

ENTERPRISE COLOR IP PHONE



USER GUIDE

UC860(P)

Version:1.0.3.82

Notices Information

Copyright

Copyright © 2005 - 2015 Nanjing Hanlong Technology CO., LTD. All rights reserved.

Nanjing Hanlong Technology Co., LTD. owns all the right to revise and change this document at any time. And all the illustrations and instructions in this paper are subject to the copyright protection of legal law. No parts of this document may be used or reproduced, transmitted by the third parties for any purposes without the express written permission of Nanjing Hanlong Technology Co., LTD.

When this document is made available on www.h-tek.com , hanlong Technology Co., LTD. gives its right to download and print copies of this content only for private use as a user manual. No parts shall have the right to alter, modify or use as commercial means without the express written permission of Nanjing Hanlong Technology Co., LTD.

Safety cautions

- To use the Phone follow the instructions in this manual.
- To use the power adapter that delivered with the phone. Other power adapters may damage the phone.
- The phone is only for indoor use. And also avoid in high humidity, water and some other liquids.
- Do not use the phone during thunderstorms.
- CE
- FCC

WEEE Warning



To avoid the potential effects on the environment and human health as a result of the presence of hazardous substances in electrical and electronic equipment, end users of electrical and electronic equipment should understand the meaning of the crossed-out wheeled bin symbol. Do not dispose of WEEE as unsorted municipal waste and have to collect such WEEE separately.

Cleaning

To clean the device, use an anti-static cloth. Please avoid cleaning liquids as they might damage the surface or internal electronics of the phone.

Table of Content

Notices Information	1
Copyright	1
Safety cautions	1
WEEE Warning	1
Cleaning	1
Table of Content	2
Getting Started	6
Packing List	6
Phone Installation.....	8
1. Attach the Foot stand.....	8
2. Connect the Handset and optional Headset.....	9
3. Connect the Network and Power.....	9
Initialization	10
Status	10
Registration	12
Idle Screen	14
Getting Familiar with Your Phone.....	15
Hardware Components Preview.....	15
Icon Preview	18
LED Instruction.....	22
Power Indicator LED	22
Line LED:(Line or Memory Key set as Line).....	22
BLF or BLF List Key LED :(Line/Memory Key set as BLF).....	23
Shared Line Key LED :(Line/Memory Key set as Shared Line)	23
Other Key Led.....	23
Info Key Instruction	24
User Interface	25
Memory Key Function Overview	27
Basic Setting Configuration	28
Web Login.....	28
Administrator Password.....	29
Basic Network Setting	31
WAN Port.....	31
PC Port	33
Display Mode	36
Language.....	37
Time and Date	38
Ring Tone.....	42
Volume	45
Wallpaper	47
Screen Saver.....	48

LED Status Setting.....	51
Backlight.....	51
Contact Management.....	51
Local Directory.....	52
Remote Phonebook.....	57
Call History.....	58
LDAP Phonebook.....	61
Broadsoft Phonebook.....	63
Call log.....	64
Other features settings.....	65
Dial Plan.....	65
Emergency Call.....	66
LED Status Setting.....	67
Action URL.....	68
Softkey Layout.....	68
Programmable Key.....	70
Ext Key.....	70
Basic Call Features.....	71
Place a Call.....	71
End a Call.....	73
Redial a Call.....	73
Receive a Call.....	73
Incoming Call Show Mode.....	74
Auto Answer.....	75
Call Hold.....	76
Call Transfer.....	76
Call Conference.....	79
Call Forward.....	81
Call Return.....	85
Call Waiting Tone.....	86
Hide Caller ID.....	87
Reject Anonymous.....	88
Call Mute.....	89
DND.....	90
Key as Send.....	90
No Key Entry Timeout.....	91
Keypad Lock.....	92
Hot Line.....	93
Function Key Features Settings.....	95
Line.....	95
Speed Dial.....	95
BLF.....	96
BLF List.....	98
Voice Message.....	100
Direct Pickup.....	101

Group Pickup	102
Call Park.....	103
Intercom	104
DTMF	106
Prefix.....	107
Local Group	108
XML Group.....	109
LDAP	110
XML Browser	111
Broadsoft Group.....	112
Conference	113
Forward	114
Transfer	114
Hold.....	115
Group Listening	116
DND.....	116
Redial	117
SMS.....	118
Send SMS.....	118
Set SMS Memory Key	119
Record.....	119
URL Record	120
Paging	121
Shared Line	122
Public Hold	123
Private Hold	124
Share line	125
Hot Desking	126
ACD (Pending)	127
Zero Touch.....	128
Upgrade	130
Factory Reset	130
Pcap Feature.....	130
System Log	131
Upgrade.....	131
Configuration File.....	133
Troubleshooting.....	135
Why is the phone LCD screen blank?.....	135
Why does the phone display "Network Unavailable"?	135
Why can't I get a dial tone?	135
Where to set the tone?.....	135
How to download XML Configuration?	136
How to Import Trusted CA certificate?.....	136
How to Import Server CA certificate?	137
How to use Vlan?.....	137

How to use LLDP?.....	137
How to Set LCD and Web GUI:	137
How to Upgrade via FTP?	138
How to make Ringtone?.....	138
How to use Open VPN?	138
Provisioning Guide on Free PBX:.....	138
Failover Notes	138
How to Upload Wallpaper?	138
How to Use Auto Provision Phonebook?	138
All Documents	138

Getting Started

Packing List

The package contains the following parts, please check if all the items are not missed:

1. The phone device

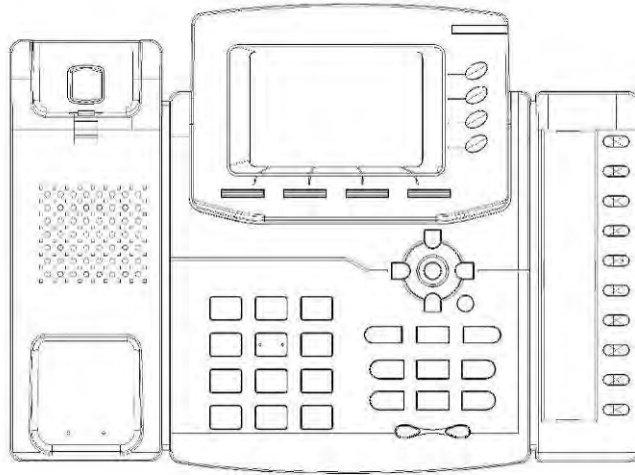

2. The footstand

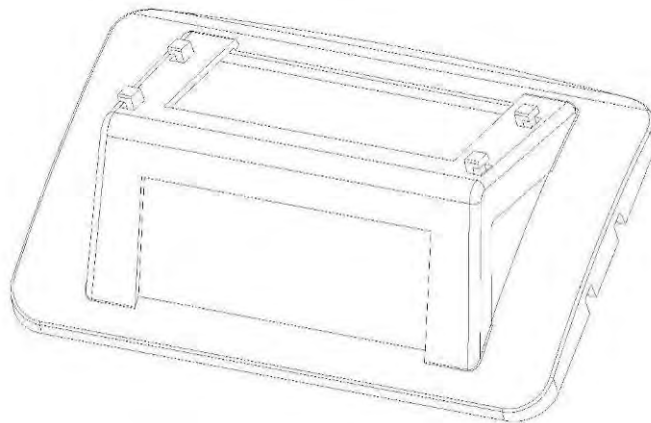

3. Handset



4. Headset cord

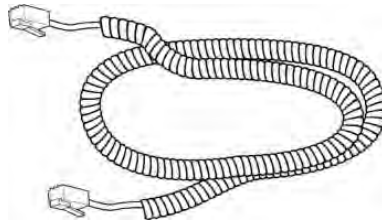

5. Power adapter

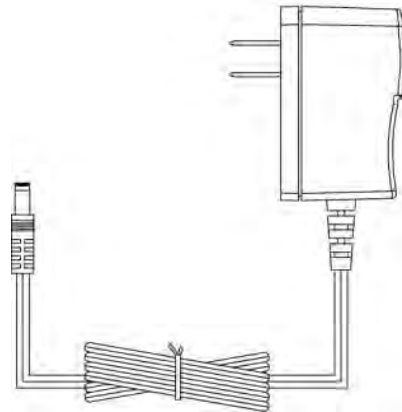

6. Ethernet cable

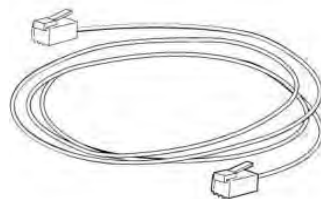

7. Quick installation reference



Phone Installation

1. Attach the Foot stand

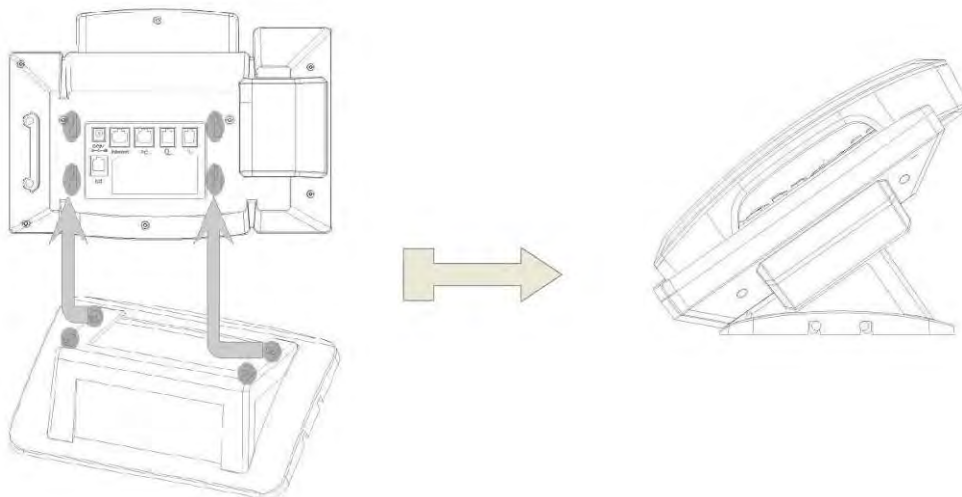

2. Connect the Handset and optional Headset

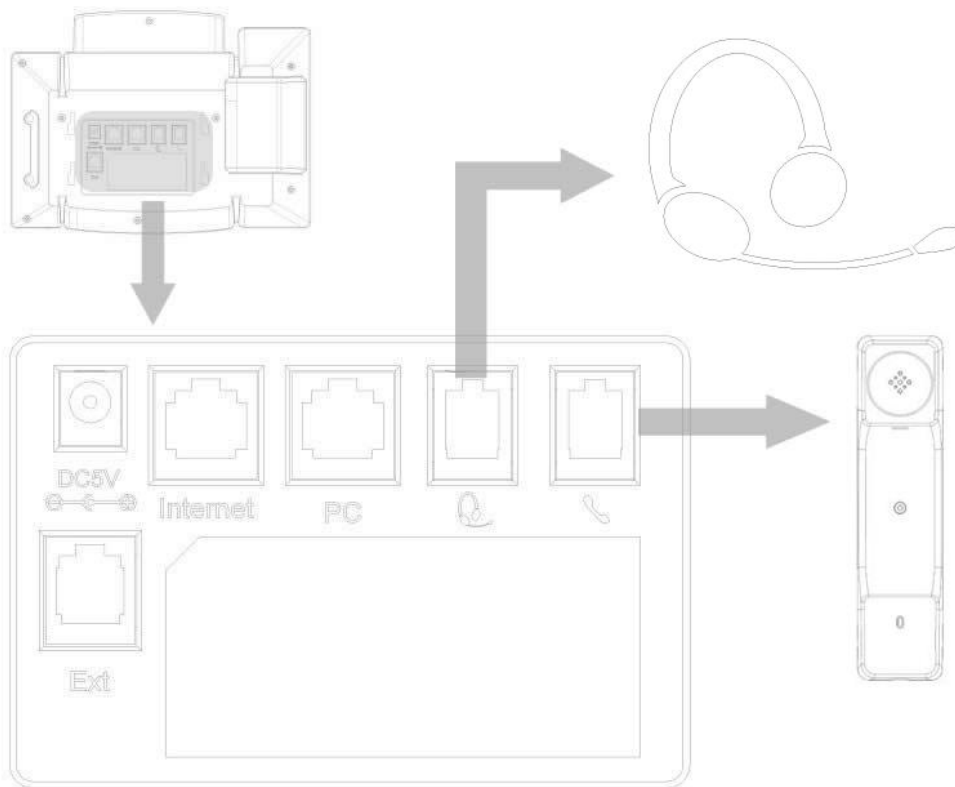

3. Connect the Network and Power

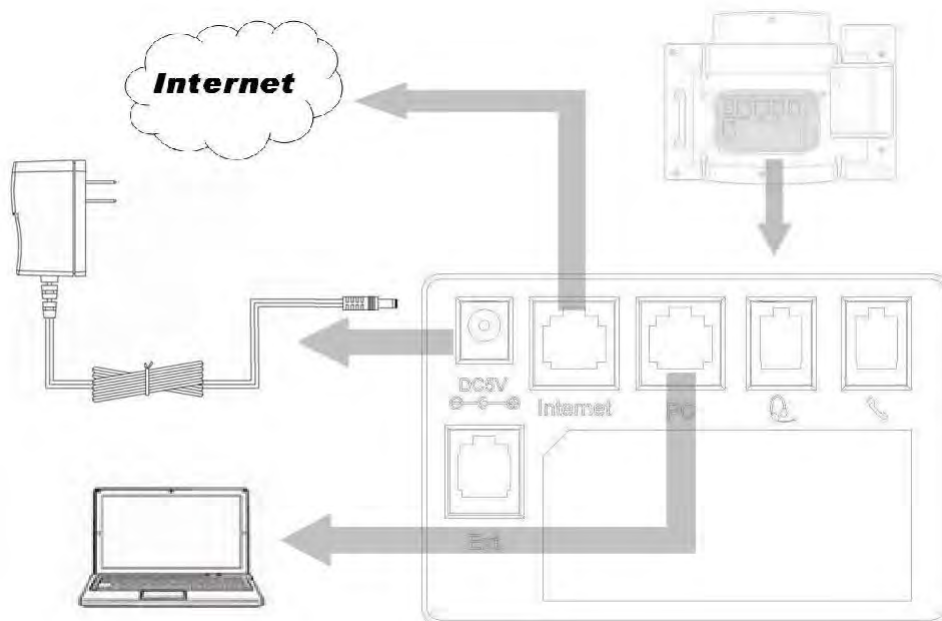

Initialization

After your phone has been powered up, the system boots up and performs the following steps:

Automatic Phone Initialization

The phone finishes the initialization process by loading the saved configuration. The phone LCD screen will display "Booting"

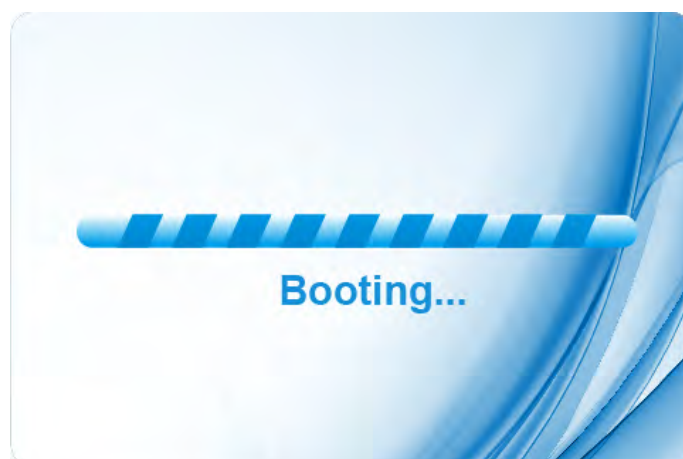

And then show "Initializing" during the initialization.

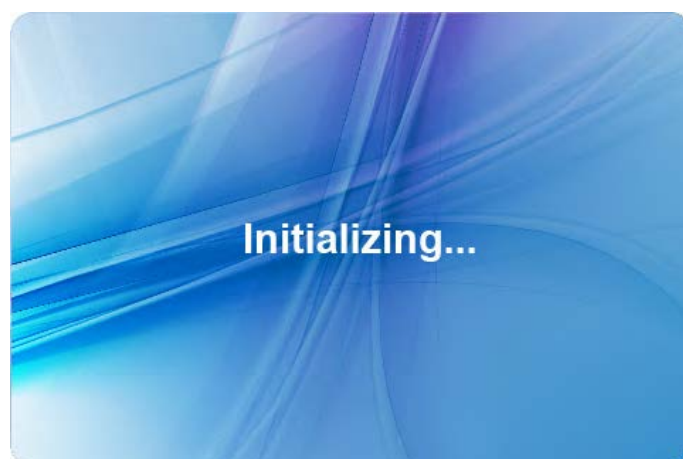

By default the phone attempts to contact a DHCP server in your network in order to obtain its valid network settings, e.g. IP address, subnet mask, default gateway, DNS server.

Status

You can view the system status of your phone via phone user interface or web user interface. The information of phone status includes: Information(e.g., Model, IP, MAC, Firmware, Hardware), Network(e.g., WAN Type, IP, Mask, LAN Type, Gateway, DNS...)Account (e.g., register status

of accounts)

To view the phone status via phone interface:

1. Press Menu → Status → Information/ Account



2. Press Menu → Status → Network

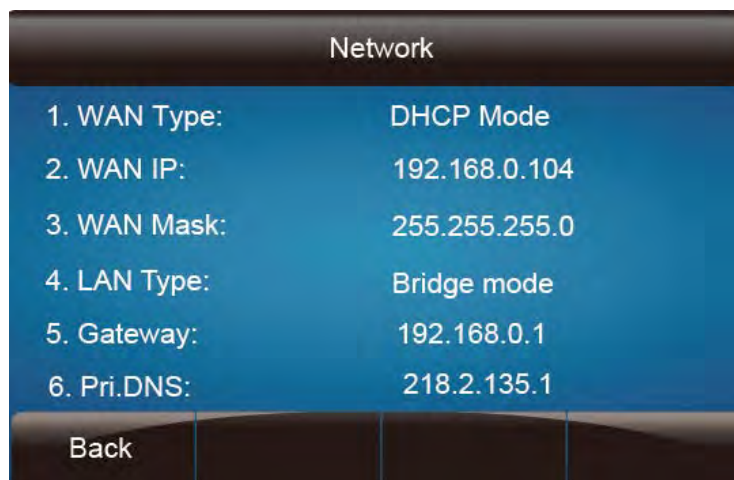

3. Press Menu → Status → Account



To view the phone status via Web interface:

Login webpage(For How to login, please refer to [Web Login](#))

View the information of Version, Account and Network.

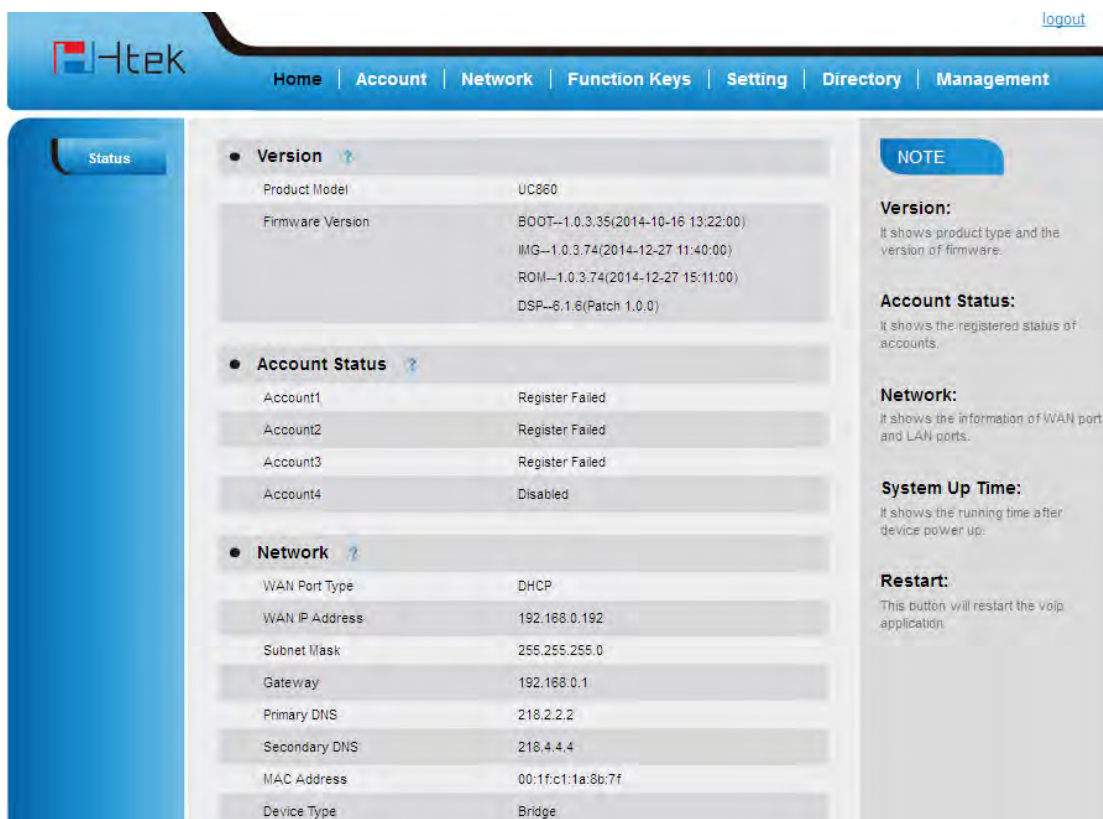

Registration

To register via phone interface:

Press Menu → Setting → Advanced setting (default password:admin) → Accounts

Select the desired account

Select Enable for Account active

Filled the SIP Server

Filled the Failover SIP server if need (Optional)

Filled the Outbound Proxy (Optional)

Filled the SIP User ID, Authenticate ID

Filled the password, Name (shown on LCD) and Ringtone.

Press Save to save the configuration.



To register via web interface:

1. Login webpage and Click Account → Basic
2. Select the desired Account
3. Select Yes for Account Active
4. Filled the Primary SIP SERVER and other account information
5. Click  to save the configuration.

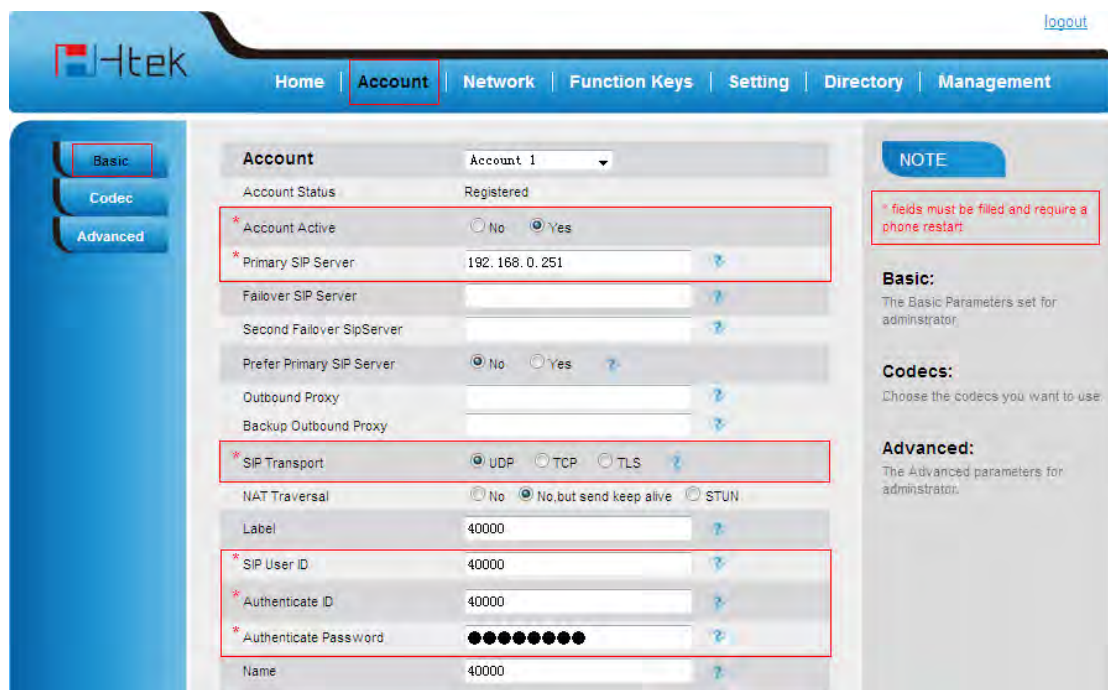



Note:

1. All fields with * must be filled. If changed, it requires a phone restart.
2. Account Status says the account registered successfully or not.
3. When change the account information via phone, it will show Restart note when back to idle page.

Idle Screen









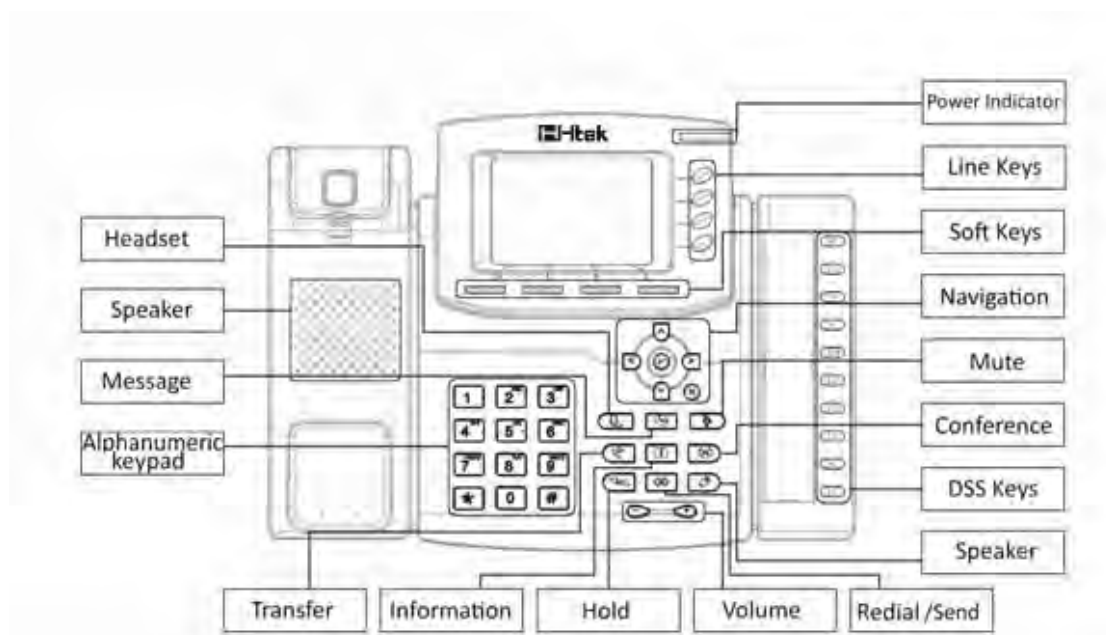

Name	Description
1. Date&Time	It shows the phone's time & date. For Date&time setting, see Time&Date
2. Notice	It shows the phone features status, More see Icon Preview
3. Line Keys	This area shows the four line key labels. Line keys are also can be used as other function keys. For more information you can refer to Memory Keys
4. Soft Key	This area shows the soft key labels. The default soft key labels are "History", "Directory", "DND" and "Menu". More to see Programmable Key
5. Default Account	This shows the current use account. User can use   to change the default use account.
6. Wallpaper	This shows the backgrounds picture. You can also change it. For more information you can refer to Wallpaper .











Getting Familiar with Your Phone

Hardware Components Preview





























Item	Description
LCD screen	To Presentation all information about the date& time, accounts, soft keys, messages, calls and other some information.
Power Indicator LED	To indicate the power status
Line keys	The phone supported up to 4 accounts 1. Steady green: idle interface, during a call.. 2. Blink red: a call incoming
Soft keys	Labels automatically to identity their context-sensitive features.
Navigation keys	<p>  1. OK. </p> <p>  Up arrow key: To move up of the selection shows on the screen. </p> <p>  Right arrow key: To move right of the selection shows on the screen. </p> <p>  Left arrow key: To move left of the selection shows on the screen. </p> <p>  Down arrow key: To move down of the selection shows on the screen. </p> <p>  1. To return to idle screen. 2. To cancel the information or call on the screen. </p>
Mute key	 1. To mute the voice during the call (green light). 2. To un-mute the call.
Conference	 To place a conference call
Memory Keys	To be configured as different function as: <ol style="list-style-type: none"> 1. Line 2. Speed Dial 3. BLF 4. BLF List 5. Voice mail 6. Direct Pickup 7. Group Pickup 8. Call Park 9. Intercom 10. DTMF 11. Prefix 12. Hold

Phone

	<p>13. Conference 14. DND 15. Redial 16. Transfer 17. SMS 18. Hot -desking 19. Call Return 20. Paging 21. Record 22. Shared Line</p> <p>The LED lights status when set as Shared line: Stay green: Idle Stay red: Busy Blinked green: Ring Back Blinked red: A call incoming Steady orange: During a call Blinked orange: Public Hold Blinked green: Private Hold Light Drown: Unregistered</p>
Speaker	 Press this button to place a call in hands-free mode.
Redial	 To dial the previous dialed number. To act as send key.
Volume	 To decrease the volume.  To increase the volume.
Hold	 To hold or to resume a call during a conversation.
Information	 To show the accounts status and some other relevant information. More refer to Info key instruction .
Transfer	 To transfer a call to a third party.  To enable or disable Forward feature during the idle page.
Alphanumeric keypad	To enter the phone numbers, letters and so on.
Message	 To indicator the New message, and press to read.
Headset	 To indicate that the phone is or not in Headset mode.

Icon Preview



Icon	Description
	Network available
	Network down
	Line(Registered succeed)
	Line (Unregistered)
	Line(Ringing)
	Speed Dial
	BLF
	BLF(Ringing)
	BLF(Talking)
	Speakerphone mode
	Handset mode
	Headset mode
	Voice messages





	<p>Text message</p>
	<p>Mute</p>
	<p>Do Not Disturb</p>
	<p>Volume is 0</p>
	<p>SRTP</p>
	<p>Hold</p>
	<p>Dialed calls</p>
	<p>Received calls</p>
	<p>Missed calls</p>
	<p>Forward calls</p>
	<p>Conference</p>
	<p>Keypad locked</p>
	<p>Keypad unlocked</p>
	<p>Pick up</p>

Phone

	<p>Call Park</p>
	<p>Intercom/Paging</p>
	<p>DTMF</p>
	<p>Prefix</p>
	<p>XML Group</p>
	<p>Local Group</p>
	<p>XML Browser</p>
	<p>LDAP</p>
	<p>Broadsoft Group</p>
	<p>Conference</p>
	<p>Forward</p>
	<p>Transfer</p>
	<p>Hold</p>
	<p>Line on Hold</p>
	<p>DND</p>
	<p>Redial</p>

Phone

 A yellow icon representing a call return function, showing two curved lines meeting at a point.	Call Return
 A blue icon representing an SMS message, showing an envelope with a paper sticking out.	SMS
 A red icon representing a recording function, showing a solid red circle.	Record

	Recording
	Group Listening
	Shared Line
	Other Functions

LED Instruction

This part mainly instructs the LED status. The Power LED Status describe on the premise that the LED setting all set as Yes. For LED status setting, please refer to: [LED Status Setting](#)

Power Indicator LED

LED Status	Description
Blinked green	Ringling or have missed call
Steady Green	Idle status(Power on)
Off	Powered off.

Line LED:(Line or Memory Key set as Line)

LED Status	Description
Steady Green	Hold
Steady Green	Offhook or during a conversation.
Blinked red	Ringling.
Off	Idle staus

BLF or BLF List Key LED :(Line/Memory Key set as BLF)

LED Status	Description
Steady Green	Idle status for the monitored line
Steady Red	The monitored line is calling or during a call
Blinked red	The monitored line is ringing.
Off	All other unknown status

Shared Line Key LED :(Line/Memory Key set as Shared Line)

LED Status	Description
Stay green	Idle status
Stay red	The line is busy
Blinked green	Ring Back, Private hold
Blinked red	The line is ringing
Steady orange	During a Call
Blinked orange	Public Hold
Off	Unregistered

Other Key Led

Key	Description
Headset Key	When use in headset mode, the led is steady green or the LED is off.
Message Key	Blinked green when there is new messages or the LED is off.
Mute Key	Red when the mute the call, or the LED is off.

Info Key Instruction

Info Key  plays many roles in this phone:

1. Quick get the Information page.



2. Get the full information of the item with *i*. When the item with *i*, it means the information is not full display or there more options for the item. Press info key, you can get the complete content or the prompt list for all options.

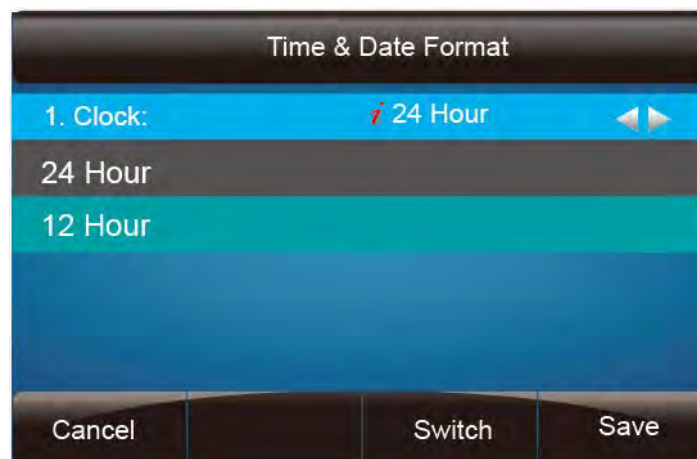

3. Fast access to the new missed or Forward calls, New Voicemail or Text Message.

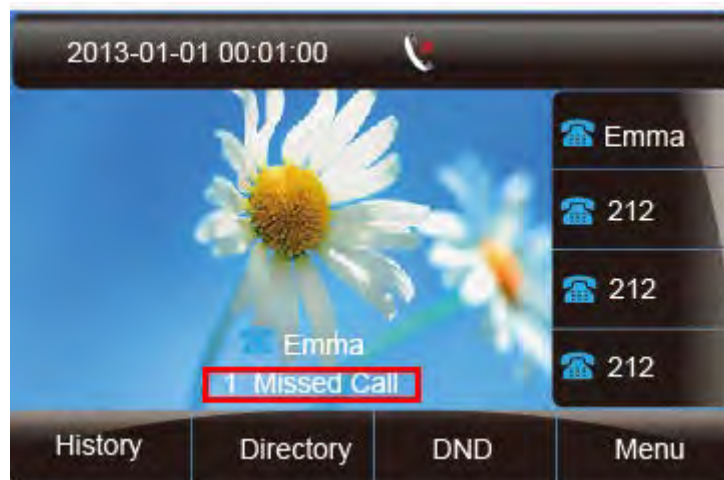

4. Get all other parties information during a conference.

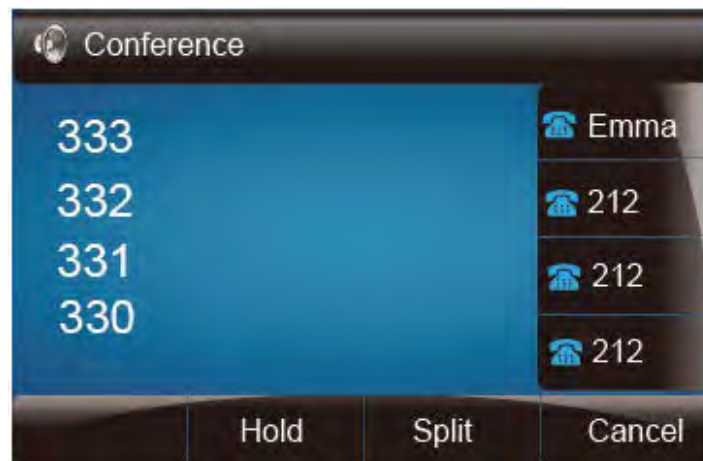

User Interface

There are two ways to customize specific configurations on your IP phone:

- The user interface on the IP phone
- The user interface in a web browser on your PC

The hardware components keypad and LCD screen constitute the phone user interface, which allows the user to execute all call operation tasks and basic configuration changes directly on the phone. In addition, you can use the web user interface to access all configuration settings. In many instances, it is possible to use both the phone user interface and the web user interface to operate the phone and change settings. However, in some instances, it is only possible to use the phone or the web user interface.

Phone Interface Overview

Option	
Status	Model
	IP
	MAC
	Firmware
	Hardware
	Network
	Account
	Device Cert
	Language
Features	Call Forward
	Function Key(Line and Memory key setting) More Key see Memory Key Overview
	Key as Send
	Hot Line
	Anonymous Call
	DND
	History Setting
Basic Settings	Language
	Time & Date
	Time & Date Format
	DHCP Time
	Ring tone
Advanced Settings	Account Registration
	Network
	Factory Reset
	Auto provision
Directory	Add, view and delete
History	View and delete
Message	Voice Mail set and View. Text Message view and set.
Display	Display Mode
	Wallpaper
	Screensaver
Others	Factory Function
	System Restart
	Device Reboot
	Pcap Feature

Memory Key Function Overview

<u>Line</u>
<u>Speed Dial</u>
<u>BLF</u>
<u>BLF List</u>
<u>Voice Mail</u>
<u>Direct Pick Up</u>
<u>Group Pick Up</u>
<u>Call Park</u>
<u>Intercom</u>
<u>DTMF</u>
<u>Prefix</u>
<u>Local Group</u>
<u>XML group</u>
<u>LDAP</u>
<u>XML Browser</u>
<u>Broadsoft group</u>
<u>Conference</u>
<u>Forward</u>

Transfer
Hold
Group Listening
DND
Redial
Call Return
SMS
Record
URL Record
Paging
Shared Line
Public Hold
Private Hold

Basic Setting Configuration

This part will mainly introduce the basic configuration as the Time, Language, and Volume...

Web Login

1. Get the IP address: Press Menu → Status → Information.



2. Input the IP Address in the web browser.
3. Input the user name (default is admin), password (default is admin).
4. Login successfully.

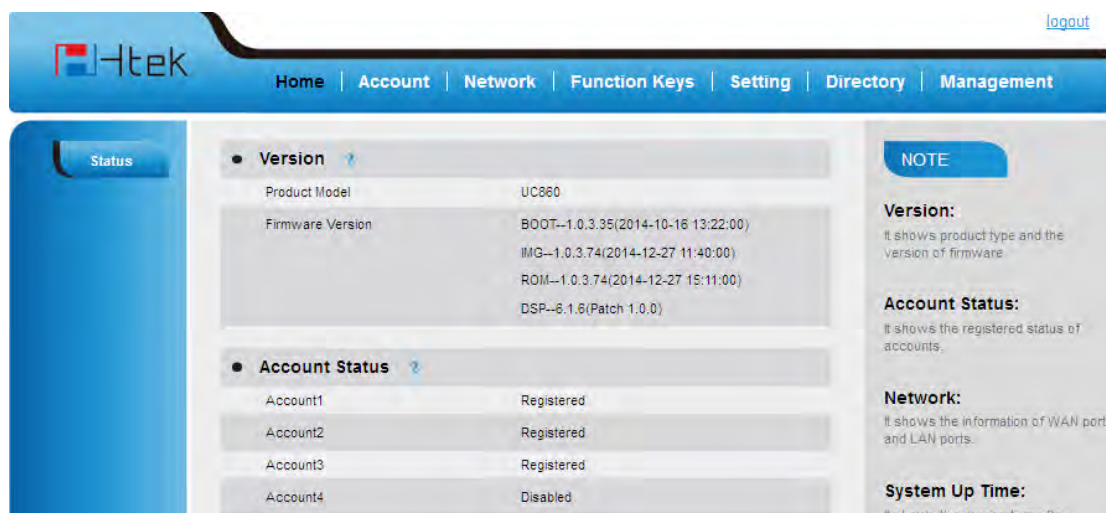

Note:

The PC and phone should be in the same segment.

When register the accounts in web and the server port is not “5060”, then “SIP Server” should be set as “SIP Server’s IP address: server port.”, for example, “192.168.0.122: 5090”.

Administrator Password

The password is mainly used for login the web interface or set the advanced settings through phone interface. And the default password of the administrator is: **admin**

To change to password via Phone Interface

1. Press Menu → setting → Advanced settings → password (default admin) → Phone Setting → Set Password
2. Enter the current PWD (password), new password and confirm the new password.
3. Press save soft key or  to save the new password.



The image shows a mobile phone screen titled "Set Password". It has three input fields: "1. Current PWD:", "2. New PWD:", and "3. Confirm:". At the bottom, there are four buttons: "Cancel", "2aB", "Delete", and "Save".

To change to password via Web Interface

1. Management → Password
2. Fill the value
3. Click  to save the configuration.

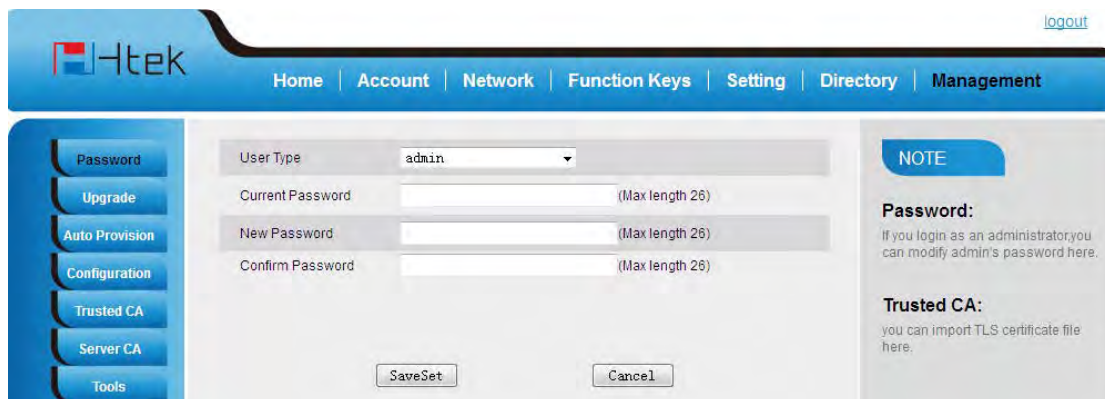

The image shows a web interface for changing the password. The top navigation bar includes "Home", "Account", "Network", "Function Keys", "Setting", "Directory", and "Management". The "Setting" menu is expanded to show "Password", "Upgrade", "Auto Provision", "Configuration", "Trusted CA", "Server CA", and "Tools". The "Password" section is active, showing a "User Type" dropdown set to "admin". There are three input fields for "Current Password", "New Password", and "Confirm Password", each with a "(Max length 26)" label. At the bottom, there are "SaveSet" and "Cancel" buttons. A "NOTE" box on the right states: "Password: If you login as an administrator, you can modify admin's password here." and "Trusted CA: you can import TLS certificate file here."

Note:

When you use the web interface: user name: admin password: admin(default)

Basic Network Setting

Htek IP Phone support three mode of Network: DHCP, Static, and PPPoE. The default mode is DHCP, it will obtain IP address and other information automatically.

If your phone cannot contact a DHCP server for any reason, you need to configure a static IP address manually.

When switch DHCP, Static IP and PPPoE to each other, or change the Static IP on webpage, it will show the warning of restart as following.

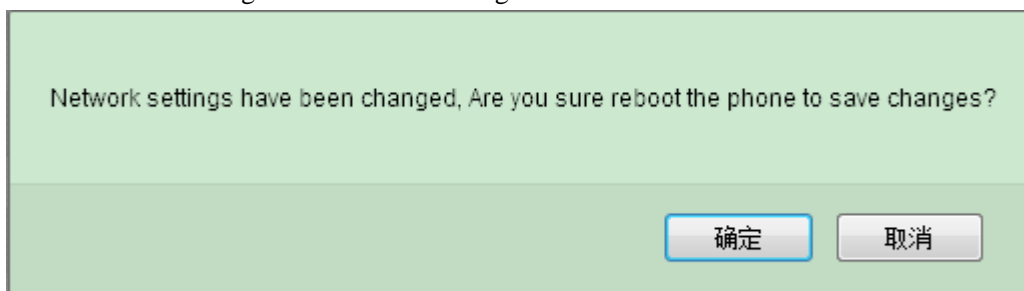

WAN Port

To configure a static IP address via phone interface:

1. Press Menu→Setting→Advanced Settings (password: admin) →Network→WANPort →Static mode.
2. Enter the parameters: IP, Netmask, Gateway, Pri. DNS(primary dns), sec. DNS(second DNS) in the corresponding fields.

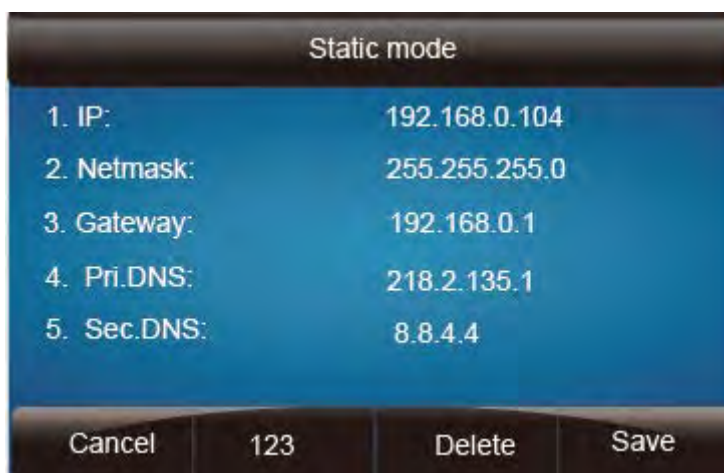

3. Click Save and restart the phone.

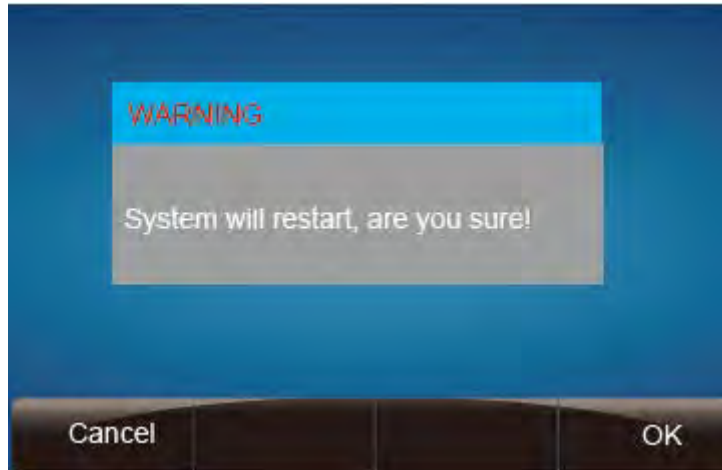

Press the Save soft key to accept the change or the Cancel soft key to cancel. If you are using an xDSL modem, you can connect your phone to the Internet via PPPoE mode. You can set a WAN port to be a PPPoE port. The PPPoE port will perform a PPP negotiation to obtain the IP address. Contact your system administrator for the PPPoE user name and password.

To configure PPPoE via phone interface:

1. Press Menu→Setting→Advanced Settings (password: admin) →Network→WANPort →PPPoE mode.
2. Enter the User ID and password
3. Click Save and restart the phone.

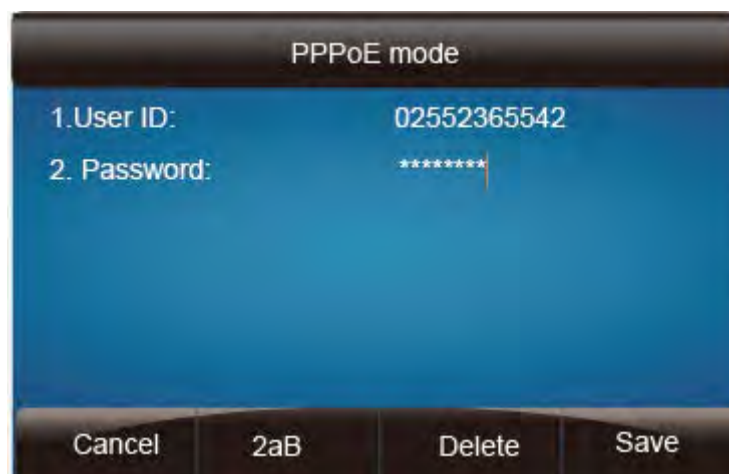

To configure DHCP via phone interface:

1. Press Menu→Setting→Advanced Settings (password: admin) →Network→WANPort →DHCP mode.

2. Click Save and restart the phone.

To configure Network via web interface:

1. Click Network→Basic
2. Select the desired Type: DHCP, Static or PPPoE
3. Filled the necessary information.
4. Click the SaveSet and restart the phone.

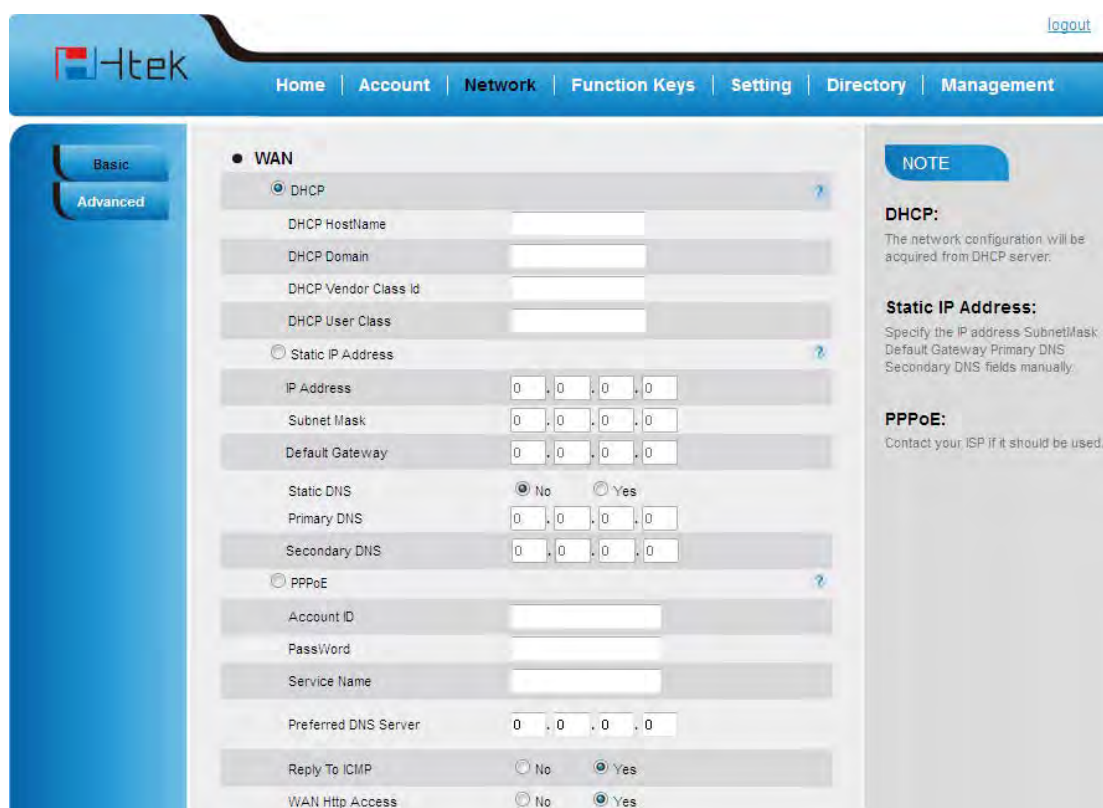

Note:

Wrong network parameters may result in inaccessibility of your phone and may also have an impact on your network performance. For more information about these parameters, contact your system administrator.

PC Port

Three modes for PC port: bridge, connect to Expansion Module and router.

To configure PC Bridge via Phone interface:

1. Press Menu→Setting→Advanced Settings (password: admin) →Network→PC Port →Bridge mode.
2. Click Save
3. Back to Idle interface and Click the OK button, then the phone will reboot.

To configure PC router via Phone interface:

1. Press Menu→Setting→Advanced Settings (password: admin) →Network→PC Port →Router mode.
2. Enter the IP, Netmask and DHCP server
3. Click Save
4. Back to Idle interface and Click the OK button, then the phone will reboot

To configure PC Connect to Expansion Module via Phone interface:

1. Press Menu→Setting→Advanced Settings (password: admin) →Network→PC Port →Connect to Expansion Module.
2. Enter the IP, Netmask and DHCP server
3. Click Save
4. Back to Idle interface and Click the OK button, then the phone will reboot

To configure Bridge via web interface:

1. Click Network→Basic
2. Select As Bridge
3. Click and the phone will reboot automatically

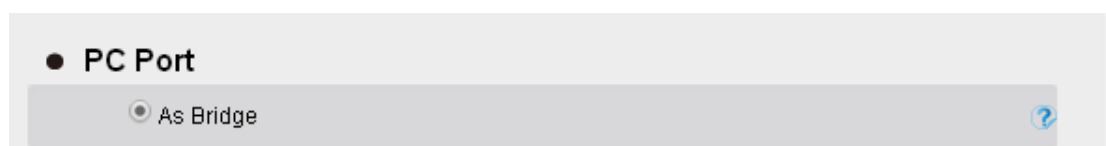

To configure Router via web interface:

1. Click Network→Basic
2. Select As Router
3. Fill the IP address and other necessary information.
4. Click and the phone will reboot automatically

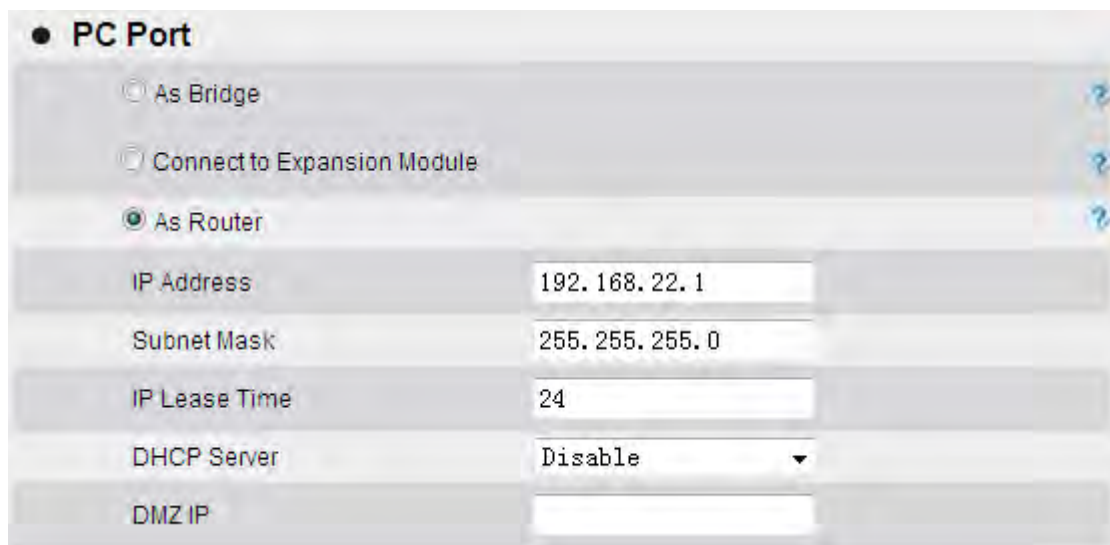

● PC Port

As Bridge

Connect to Expansion Module

As Router

IP Address	<input type="text" value="192.168.22.1"/>
Subnet Mask	<input type="text" value="255.255.255.0"/>
IP Lease Time	<input type="text" value="24"/>
DHCP Server	<input type="text" value="Disable"/>
DMZ IP	<input type="text"/>

To configure PC Connect to Expansion Module via web interface:

1. Click Network→Basic
2. Select As Connect to Expansion Module
3. Click and the phone will reboot automatically

● **PC Port**

As Bridge ?
 Connect to Expansion Module ?
 As Router ?

IP Address	192.168.22.1
Subnet Mask	255.255.255.0
IP Lease Time	24
DHCP Server	Disable ▼
DMZ IP	

Display Mode

This phone support two Display mode: Text and Icon.

Icon Mode: all Items are shown same as the main with Icon.

Text Mode: Only the 8 main item shown as Icon, and others all text description.

To Configure Display mode via phone interface:

1. Press Menu → Display → Display Mode
2. Select Text or Icon
3. Press Save soft key to save the configuration.

To Configure Display mode via web interface:

1. Login web interface, and click Setting → Preference

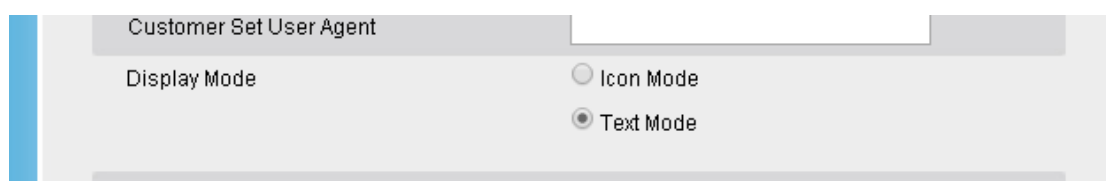

Customer Set User Agent

Display Mode

Icon Mode
 Text Mode

2. Select Icon Mode or Text Mode for the Display mode

3. Click  to save the configuration.

Language

The default Phone interface language is English.

To change the language via Phone interface

1. Press Menu → Setting → Basic Settings → Language.



2. Press  or Save soft key to save the configuration.



To change the language via Web Interface

1. Setting → Preference → Web Language
2. Select the necessary one.
3. Press  to save the configuration.





Note:

All languages may not be available for selection. The available languages depend on the language packs currently loaded to the IP phone.

Time and Date

The time and date show on the idle page, and it can be set and change by SNTP server automatically or manual setting.

To configure the time and Date by SNTP setting via phone interface



1. To press Menu → Setting → Basic setting → Time & Date → SNTP Settings
2. Press  or , or  to change the Time zone.

3. Fill the NTP server1, NTP Server2, and Daylight Saving.
4. Press  or Save soft key to save the configuration.









Note:

Press , all zone will show on the display, select the one you want and press save or confirm key to save the configuration.

To configure time and date manually via phone interface





1. To press Menu → Setting → Basic setting → Time & Date → Manual Settings
2. Press  and  or change the right time, or you can input the right time.
3. Press  or Save soft key to save the configuration.

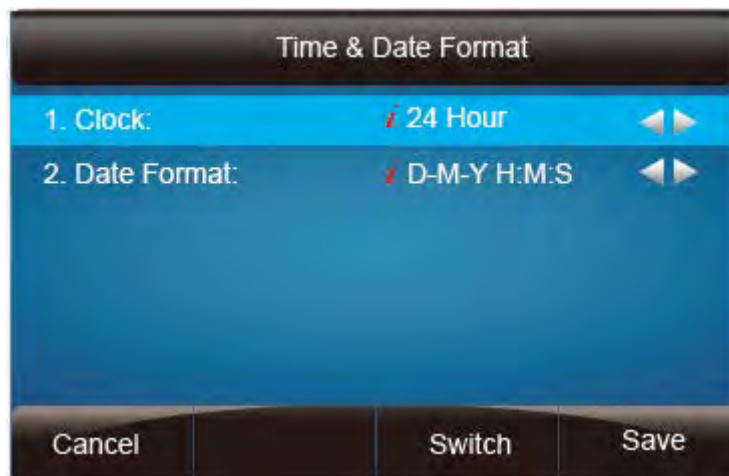

To configure the Time & Date Format via phone interface

1. To press Menu → Setting → Basic setting → Time & Date Format
2. Press  and  or press  to change between 12 Hour or 24 Hour.
3. Press  and  or press  to change among Y-M-D(year-month-day), M-D-Y(month-day-year), D-M-Y(day-month-year).
4. Press  or Save soft key to save the configuration.

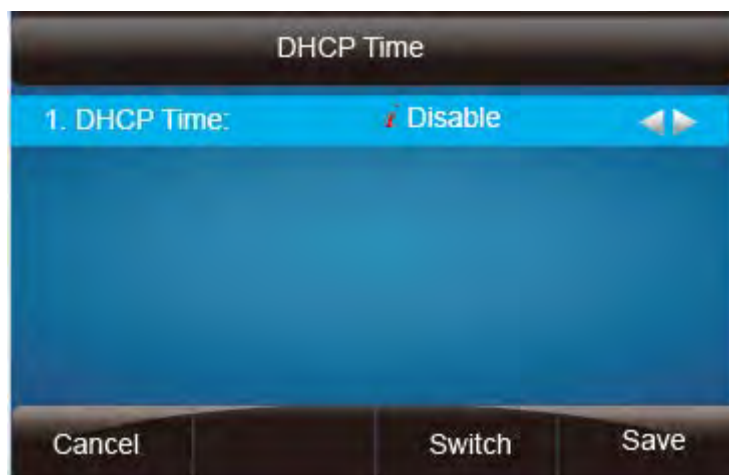

To configure the DHCP time via phone interface

1. To press Menu → Setting → Basic setting → DHCP time
2. Press  and  or press  to change between Disable and Enable.
3. Press  or Save soft key to save the configuration.



To configure the NTP Server by web interface

1. Login
Login name: admin, password: admin(default)
2. Setting → Date & Time → NTP Server
3. Fill the value in the blank.

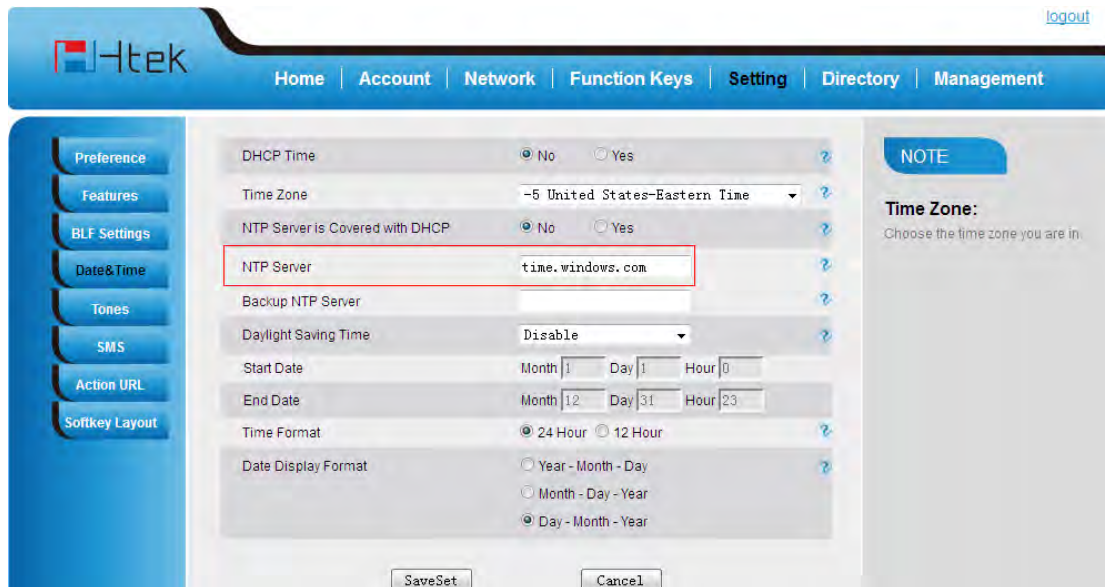

To change the Time Zone and Date Display Format via web interface

1. Setting → Date & Time
2. Select the necessary one.
3. Press  to save the configuration.

[logout](#)

[Home](#) | [Account](#) | [Network](#) | [Function Keys](#) | **[Setting](#)** | [Directory](#) | [Management](#)

Preference

Features

BLF Settings

Date&Time

Tones

SMS

Action URL

Softkey Layout

DHCP Time	<input checked="" type="radio"/> No <input type="radio"/> Yes	?
Time Zone	-5 United States-Eastern Time	?
NTP Server is Covered with DHCP	<input checked="" type="radio"/> No <input type="radio"/> Yes	?
NTP Server	time.windows.com	?
Backup NTP Server		?
Daylight Saving Time	Disable	?
Start Date	Month 1 Day 1 Hour 0	
End Date	Month 12 Day 31 Hour 23	
Time Format	<input checked="" type="radio"/> 24 Hour <input type="radio"/> 12 Hour	?
Date Display Format	<input type="radio"/> Year - Month - Day <input type="radio"/> Month - Day - Year <input checked="" type="radio"/> Day - Month - Year	?

NOTE

Time Zone:
Choose the time zone you are in.

Note:

If the IP Phone cannot obtain the time and date from the Simple Network Time Protocol (SNTP) server, please contact your system administrator for more information.

Ring Tone

You can adjust the type and volume of the ring tone.

To adjust the Ring Tone Type via Phone interface:

1. Press Menu → Setting → Basic Settings → Ring Tone.
2. Press and to select the aimed one.
3. Press or Save soft key to save the configuration.



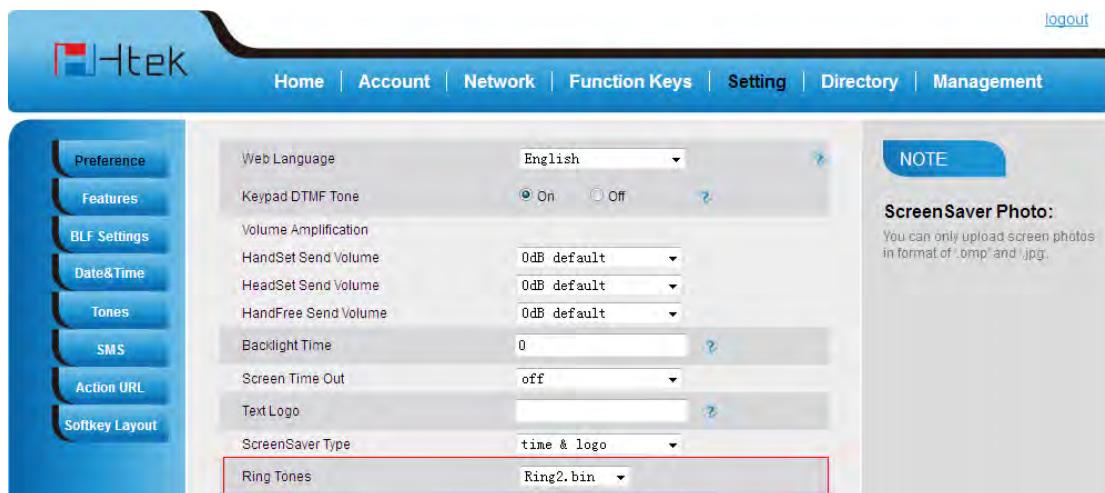

To adjust the Ring Tone Type via Web Interface

1. Setting → Preference → Ring Tone
2. Select the wanted one
3. Click  to save the configuration.



To configure Distinctive Ring Tone via Phone Interface

1. Press Directory
2. Select the target contact
3. Press Detail soft key to edit the contact.
4. Press  and  to select the wanted Ring Tone for the contact

5. Press Save soft key to save the contact.

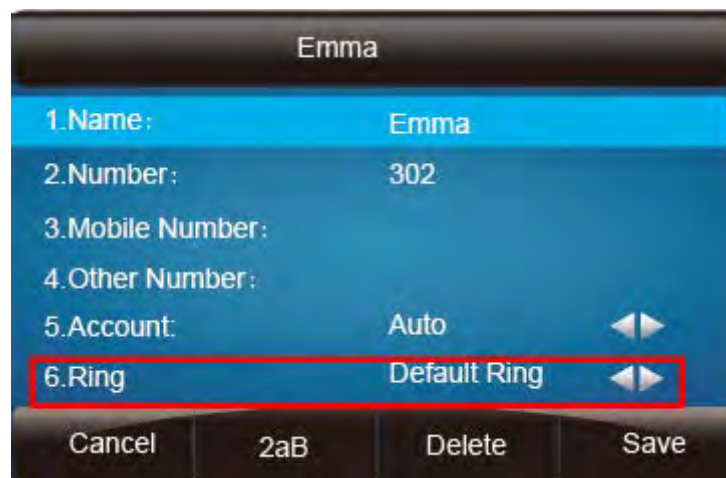

To configure Distinctive Ring Tone via Web Interface

1. Directory → Directory → Contact
2. Choose the Ring Tone you want to use.
3. Click → to save the configuration.

[Logout](#)

Home | Account | Network | Function Keys | Setting | Directory | Management

Directory

Remote Phone Book

Call History

LDAP

BroadSoft

Calllog

MultiCast Paging

Contact
BlackList
Handup

Index	Display Name	Office Number	Mobile Number	Other Number	Account	All
1	Nancy	827			Auto	<input checked="" type="checkbox"/>

Save
Delete
Move to Contact/blacklist

Contact

Name: Nancy

Office Number: 827

Mobile Number:

Other Number:

Account: Auto

Ring: Ring2.bin

Group: Not In Group

Photo: Auto

Delete Photo

浏览... 未选择文件.

Upload Photo

Import Local Contacts

NOTE

Add Contact/Blacklist
Fill out the contact information. User shouldn't leave contact name blank.

Delete Contact/Blacklist
Select the contact you want to delete in the grid, and then press the button Delete to confirm.

Move to Contact/blacklist
Choose the contacts you want to move in the grid, and press the button move to Contact/Blacklist to move it.

Upload Photo
The format of the photo supported is jpg or bmp, and the size should be less than 128 *128.

Import
Browse the file in XML format.

Export
Click Export button and create a file with whose name you prefer to export.

Click [Ring tone](#) for more information.

Volume

You can adjust the volume for the phone by the volume keys: and .

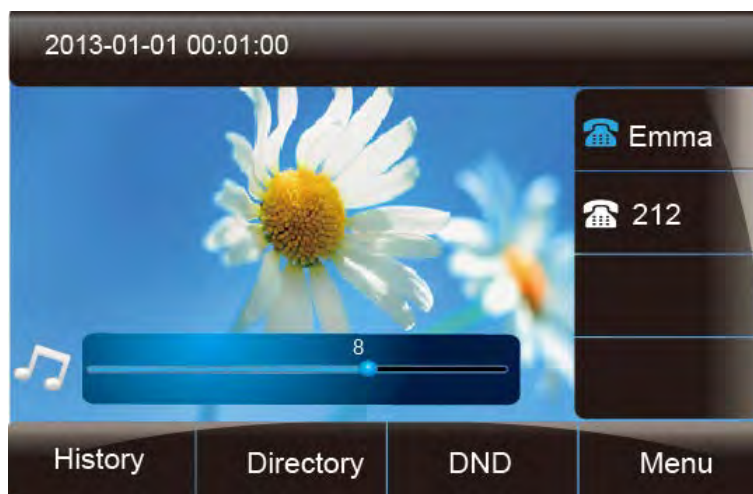

To adjust the Ring tone volume via phone interface:

- Option 1: To press and on the idle page

2. Option 2: To press and during the call is ringing.

To adjust the handset volume via phone interface:

To press and during a call in handset mode.

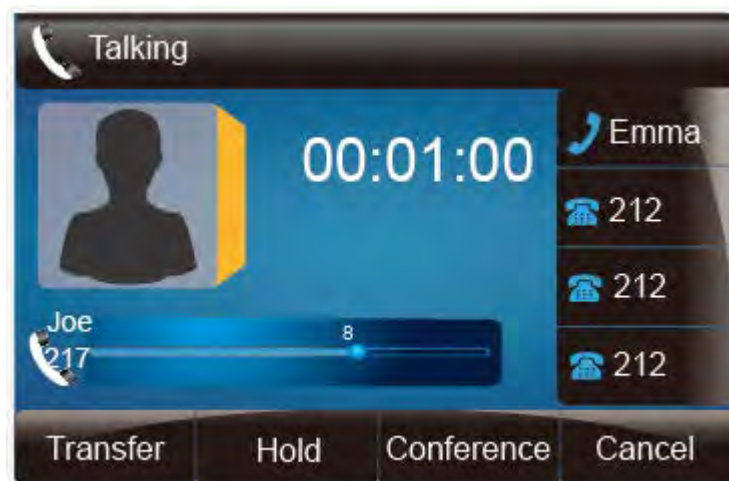

To adjust the headset volume via phone interface:

To press and during a call in headset mode.

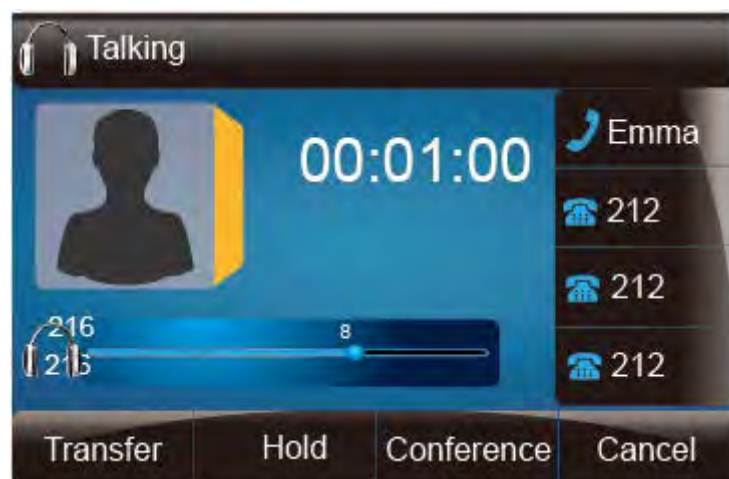

To adjust the speaker Volume via phone interface:

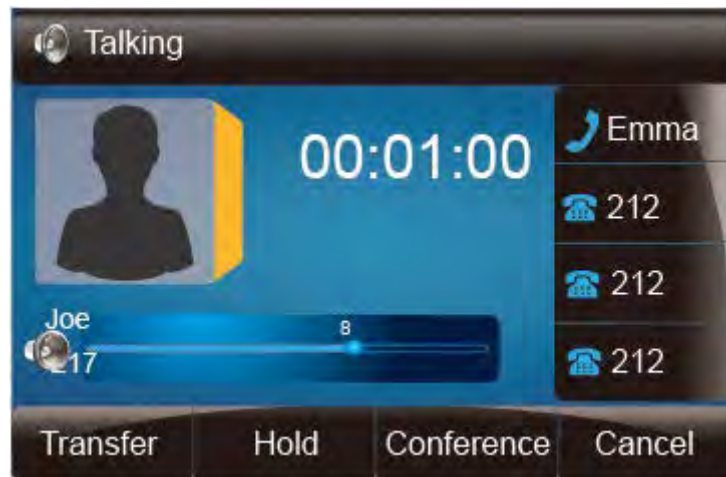

To press and during a call in speaker mode.



Wallpaper

To change the preferred one picture for you by the following steps:

To change the wallpaper via phone interface:

1. To press Menu → Display → wallpaper
2. Press  and  or press Switch soft key to display the different pictures.
3. Press  or Save soft key to save the selected picture as the wallpaper.



To change the wallpaper via web interface:

1. Click Setting → Preference
2. Select the desired wallpaper picture to upload.

3. Click to save the setting.

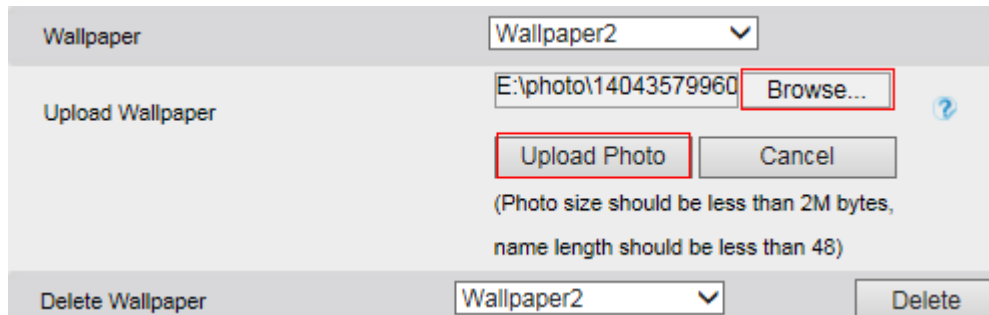

To delete the wallpaper via web interface:

1. Click Setting → Preference
2. Select the desired wallpaper to delete.
3. Click to save the setting.

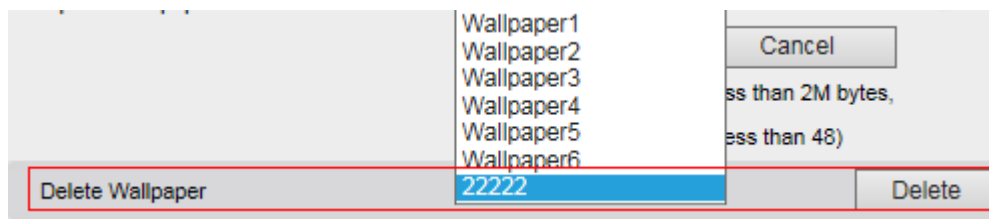

Note:

System wallpaper(Wallpaper1-Wallpaper6) can not be deleted!!!

Screen Saver

There are three types of screen saver: Time & Logo, Photo Switch and Photo.

Time & Logo: when the screensaver works, it will show Time and logo in turns.

Photo Switch: all screensaver pictures display one by one.

Phone: Only the select phone display as screensaver.

Text logo: It works with the **Time & Logo**, when enter the value, it will display the time and the entered value in turns.



To enable screen saver via Phone interface:

1. To press Menu → Display → Screensaver...
2. Press and or press Switch soft key to Choose the Time-out as 1 min or 2/5/10/30 minute.

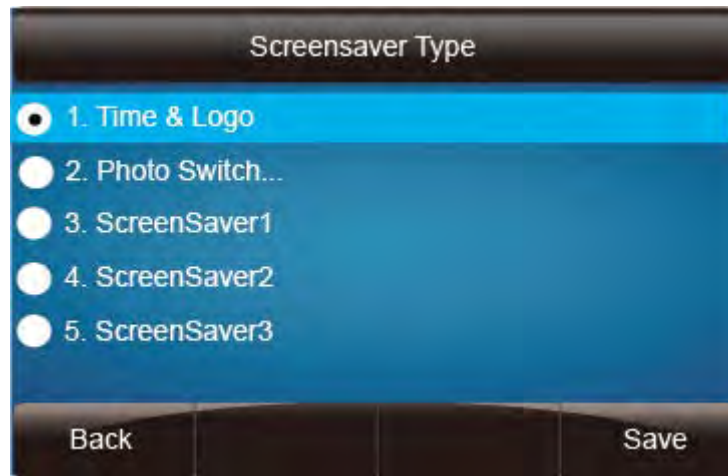
3. Enter the Screensaver Type to choose one of the type: Backlight off, Time & Logo and Photo
4. Press  or Save soft key to save the selected configuration.



To disable screen saver via Phone interface

1. To press Menu → Display → Screensaver...
2. Press  and  or press Switch soft key to Choose the Time-out as off.
3. Press  or Save soft key to save the selected configuration.

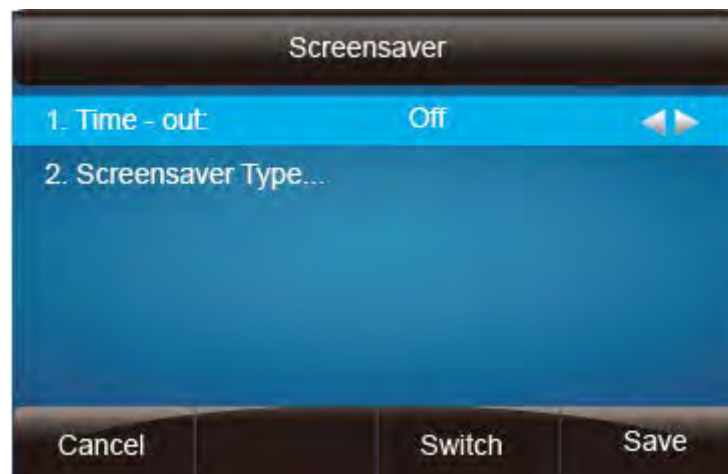

To upload screen saver via Web interface:

1. Setting → Preference
2. Choose the picture wanted to use as screen saver

3. Click **Upload Photo** to save the upload picture

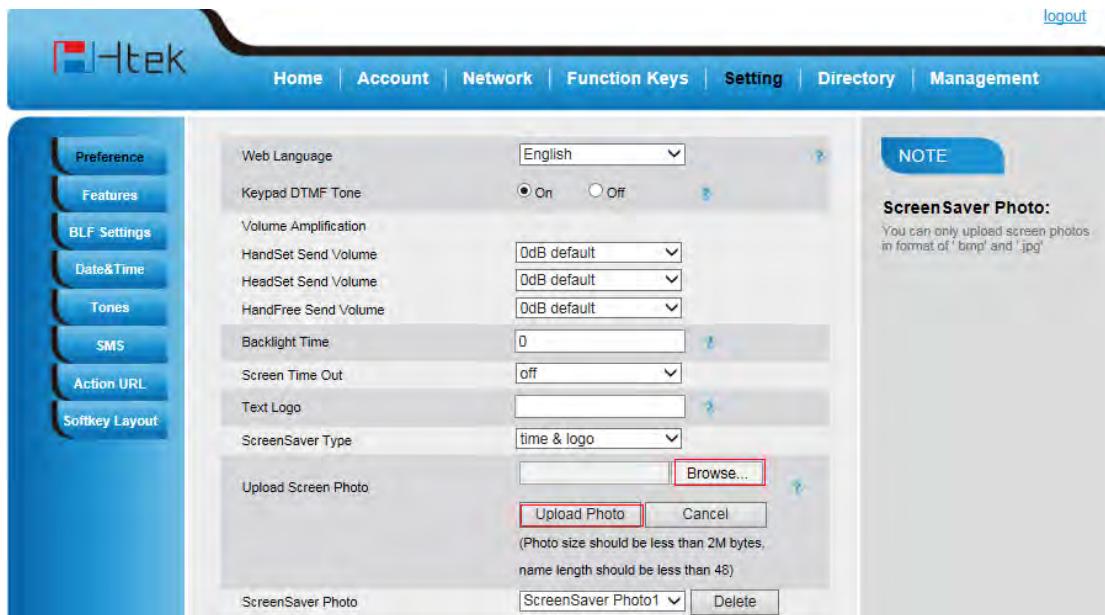

To delete upload screen saver photo via Web interface:

1. Click Setting → Preference
2. Select the photo that to delete.
3. Click Delete to delete the photo.

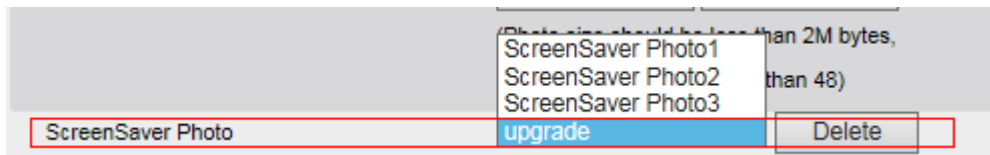

Note:

System Screen Photo(ScreenSaver1-ScreenSaver3) can not be deleted!!!

To custom text logo via web interface:

1. Click Setting→Preference.
2. choose the Time-out as 1 min or 2/5/10/30 minute.
3. Enter the desired value in the Text Logo field.
4. Click Saveset to save the configuration.

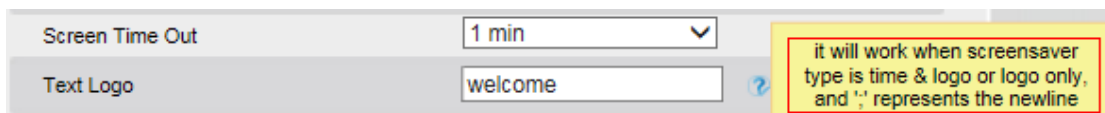

To wake up screen saver via Web interface:

1. Click Setting → Preference
2. Choose Dial First Digit: Screensaver Wakes up or Screensaver Wakes up and Dial

Dial First Digit Screensaver Wakes up
 Screensaver Wakes up and Dial

Note:

1. The upload Photo size should be less than 2M bytes, name length should be less than 48, and the File name should be letters, numbers or underline '_' and photo number should be less than 9.
2. The default screensaver photos can not be deleted.

LED Status Setting

Backlight

To set Backlight via web interface:

1. Click setting→Preference
2. Enter the time for Backlight time (In seconds).
3. Click  to save the configuration.

The default is 0, which means Backlight is always on.

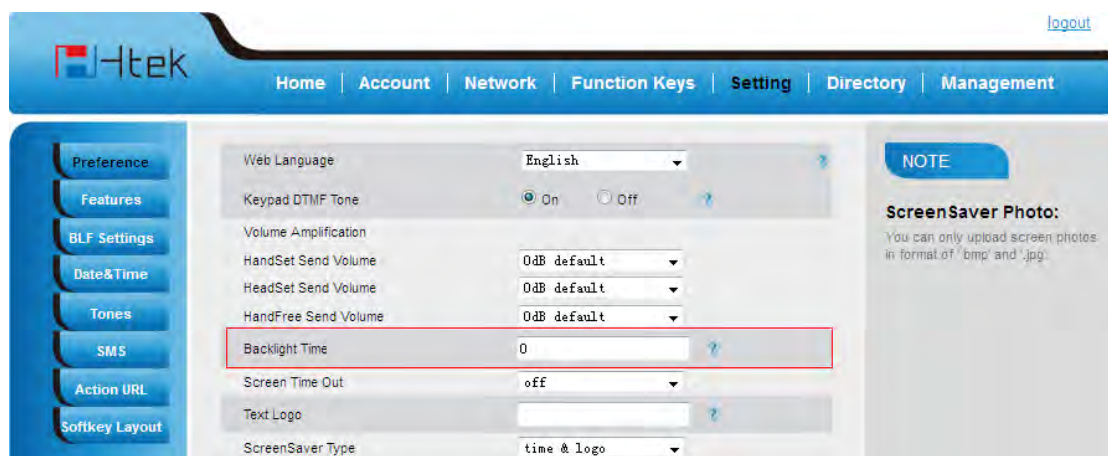

Contact Management

This section provides the operating instructions for managing contacts. The topics

include:

- Local Directory
- Blacklist
- Remote Phonebook
- Call History
- LDAP
- BroadSoft Phonebook
- CallLog

Local Directory

In the directory, you can add or delete your friends, business partner or anyone others' phone No. so you will not forget their number. Or put some anonymous phone No. in the blacklist to prevent from being disturbed. The local Directory can add up to 1000 contacts.

A. To add contacts list into local directory



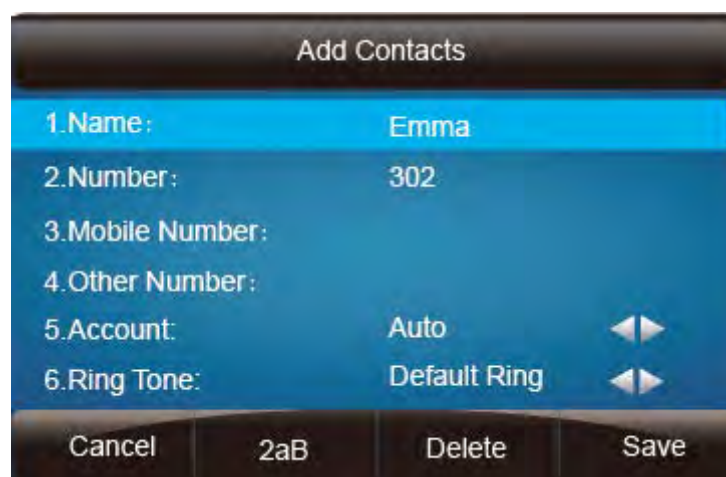

To add contacts manually via phone interface

1. Press Menu → Directory → Local Contacts
2. Press Add soft key.
3. Enter the necessary information as Name, Phone number...
4. Press save soft key or  to add the contacts successfully.



To add contacts from history via phone interface:

1. Press History soft key or press Menu → History → Local history

2. Press  and  to select the targeted one. (Press  and  switched among the All calls, Dialed calls, Received calls, Missed Calls and Forward Calls).
3. Press Option soft key → Add to Contacts
4. Edit the necessary information as Name, Phone number...
5. Press save soft key or  to add the contacts successfully.

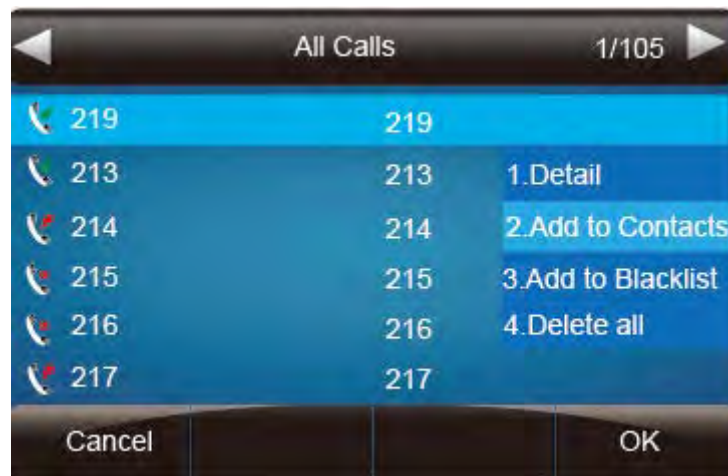

To add contacts via web interface:

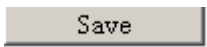

1. Click Directory→Directory
2. Enter the name, number and some other information.
3. Press  and then press  button.

B: To add contacts into blacklist

To add blacklist manually via phone interface:

1. Press Menu → Directory → Blacklist
2. Press Add soft key.
3. Enter the necessary information as Name, Phone number...
4. Press save soft key or  to add the contacts successfully.

To add blacklist from history via phone interface:

1. Press History soft key or press Menu → History → Local history
2. Press  and  to select the targeted one.
3. Press Option soft key → Add to Blacklist
4. Edit the necessary information as Name, Phone number...
5. Press save soft key or  to add successfully.

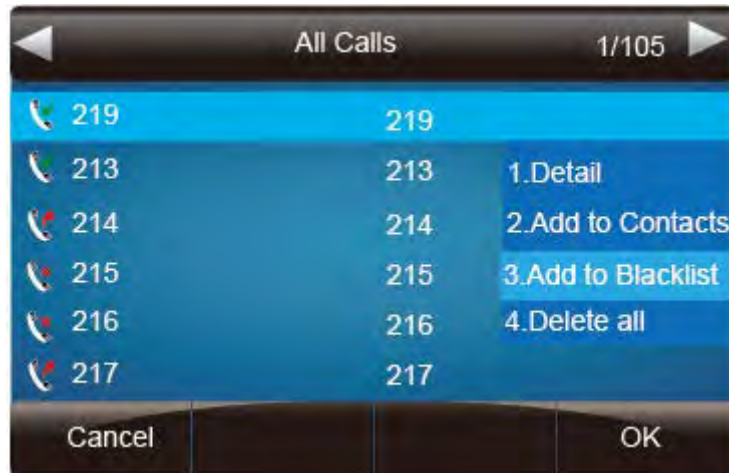

Upload Contacts photo via web interface:

1. Click Directory and select the desired contact.
2. Click Choose file to select the photo for the contact
3. Click to upload the photo.

When you place a call from the contact, the phone idle screen will show the contact photo.

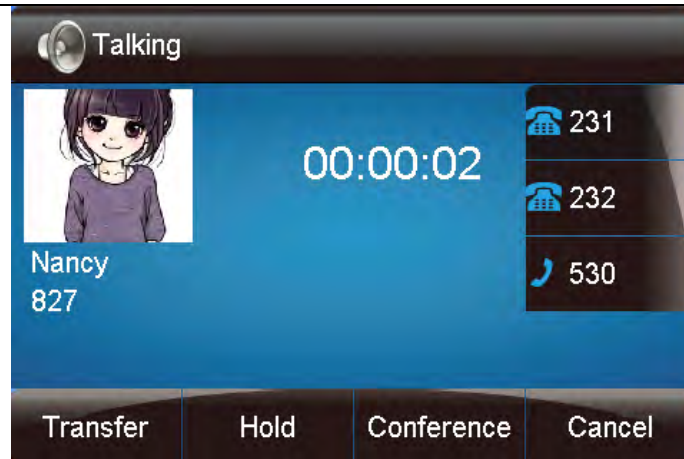
**Note:**

The format of the photo supported is jpg or bmp, and the size should be less than 128 *128

To import or export the contact list

You can manage your phone's local directory via phone or web user interface. But you can only import or export the contact list via web interface.

To import an XML file of contact list via web interface:

1. Click on Directory
2. Click Browse to select a contact list file (file format must be .xml) from your local system.
3. Click Import XML to import the contact list.

To export an XML file of contact list via web interface:

1. Click on Directory
2. Click Export XML to import the contact list.

To import a CSV file of contact list via web interface:

1. Click on Directory
2. Click Browse to select a contact list file (file format must be .csv) from your local system.
3. Click Import Csv to import the contact list.

To export a CSV file of contact list via web interface:

1. Click on Directory

2. Click Export Csv to import the contact list.



Note:

If the xml file and CSV file more than 1000 contacts, the phone will only upload 1000 contacts.

Remote Phonebook

To set Remote PhoneBook via web interface:

1. Login the webpage and click Directory→Remote Phone Book
2. Fill the path of the remote file in the Phone Book URL field.
For example,
<http://192.168.0.240/Phonebook/Phonebook.xml>
3. Fill the Name and then click to save the configuration.

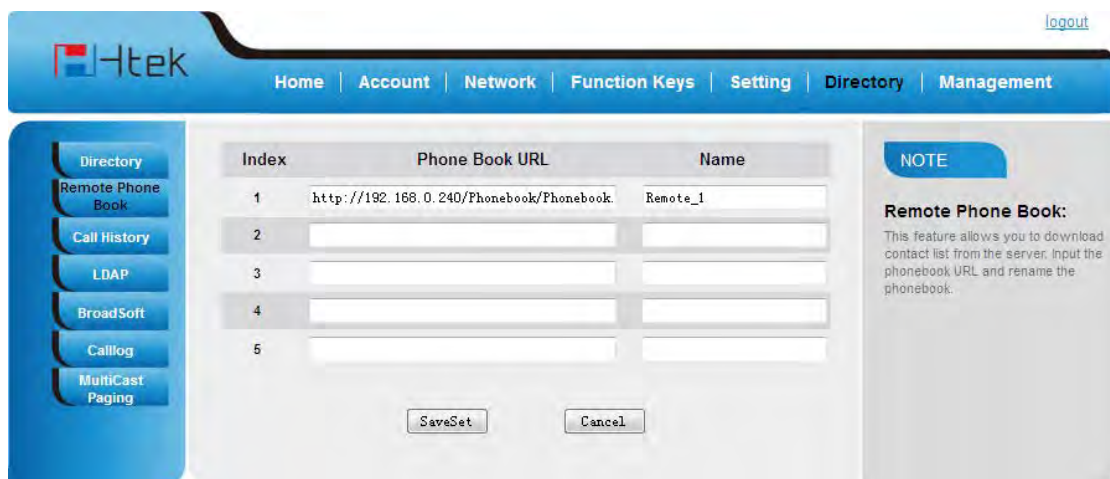

To check the contacts via phone interface:

1. Press Directory→Left Button→Left Button, and then you can see the item you set, press enter you will find the detail.

For More detail, please refer to: [Remote Phonebook](http://www.h-tek.com) on www.h-tek.com.



Note:

Every remote contact only support 1000 contacts.

Call History

This phone maintains call history lists of Dialed Calls, Received Calls, Missed Calls and Forwarded Calls. The call history list supports up to 100 entries in all on phone interface and more than 1500 items. You can check the call history, dial a call, add a contact or delete an entry from the call history list. You should enable the history record feature in advance.

To enable the history record feature via phone interface:

1. Press Menu→Feature→History Setting
2. Press  and  or Switch soft key to enable History record.
3. Press Save soft key to save the configuration.

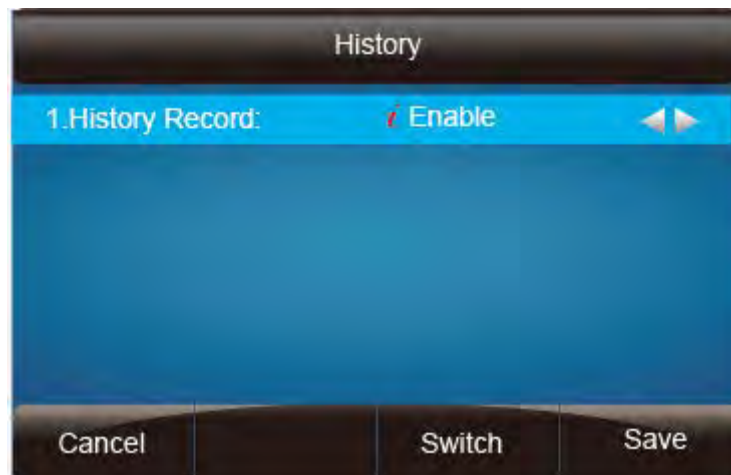
To check the call history via phone interface:

1. Press the History soft key. The LCD screen displays All Calls list.
2. Press Right or Left Key to switch among All Calls, Missed Calls, Received Calls, Dialed Calls and Forwarded Calls.
3. Press to select the desired entry.
4. Press the Option soft key, and then select Detail from the prompt list.
5. The detailed information of the entry appears on the LCD screen.

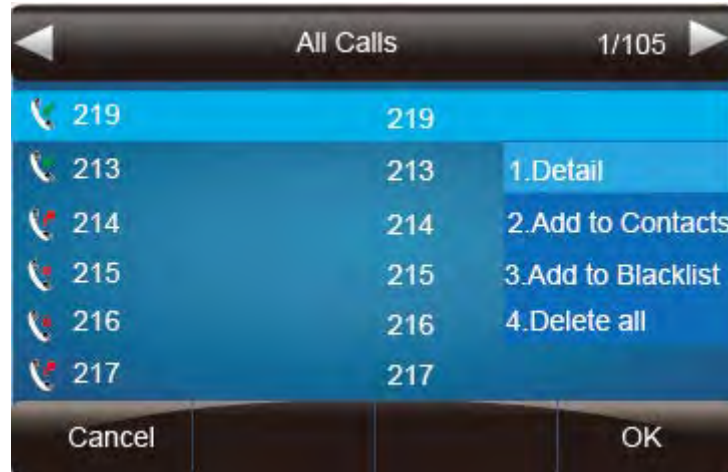

To delete an entry from the call history list via phone interface:

1. Press the History soft key.
2. Press Right or Left Key to switch among All Calls, Missed Calls, Received Calls, Dialed Calls and Forwarded Calls.
3. Press UP or DOWN key to select the desired entry.
4. Press the Delete soft key.

To delete all entries from the call history list via phone interface:

1. Press the History soft key.
2. Press Right or Left Key to switch among All Calls, Missed Calls, Received Calls, Dialed Calls and Forwarded Calls.
3. Press the Option soft key, and then select Delete All from the prompt list.
4. Press the OK soft key.
5. Press the OK soft key to confirm the deleting or the Cancel soft key to cancel.

To check the call history via web interface:

1. Click Directory → Call History
2. Click Dialed List, Missed List, Received List, Forwarded List then you can see the history list.

Dialled List						
Index	Date	Time	Local Identity	Name	Tel Number	
1	2014-06-16	04:06:51	800@192.168.0.9	810086	810086	
2	2014-06-16	04:04:05	800@192.168.0.9	910086	910086	
3	2014-06-16	03:41:35	800@192.168.0.9	910086	910086	
4	2014-06-16	03:41:29	225@192.168.0.2	910086	910086	
5	2014-06-16	03:40:22	225@192.168.0.2	910086	910086	
6	2014-06-16	03:35:24	800@192.168.0.9	910086	910086	
7	2014-06-16	03:27:44	800@192.168.0.9	910086	910086	
8	2014-06-16	03:27:39	800@192.168.0.9	910086	910086	
9	2014-06-16	03:20:03	800@192.168.0.9	910086	910086	
10	2014-06-16	02:20:53	800@192.168.0.9	915205188613	915205188613	
11	2014-06-16	01:37:39	800@192.168.0.9	803	803	
12	2014-06-16	01:36:32	800@192.168.0.9	803	803	
13	2014-06-16	01:25:51	800@192.168.0.9	915205188613	915205188613	
14	2014-06-16	00:47:46	225@192.168.0.2	320	320	
15	2014-06-16	00:45:43	225@192.168.0.2	320	320	
16	2014-06-16	00:45:08	225@192.168.0.2	320	320	
17	2014-06-16	00:42:00	225@192.168.0.2	71	71	
18	2014-06-16	00:41:55	800@192.168.0.9	71	71	
19	0000-00-00	00:03:20	225@192.168.0.2	320	320	
20	0000-00-00	00:03:07	225@192.168.0.2	320	320	

To Dial a call from Call History via web interface:

1. Click Directory→Call History
2. Select the desired history item, and click Tel Number.
3. Then the call is dialed on phone.

Dialled List						
Index	Date	Time	Local Identity	Name	Tel Number	
1	2014-06-16	06:07:29	800@192.168.0.9	810086	810086	
2	2014-06-16	04:06:51	800@192.168.0.9	810086	810086	
3	2014-06-16	04:04:05	800@192.168.0.9	910086	910086	
4	2014-06-16	03:41:35	800@192.168.0.9	910086	910086	
5	2014-06-16	03:41:29	225@192.168.0.2	910086	910086	
6	2014-06-16	03:40:22	225@192.168.0.2	910086	910086	
7	2014-06-16	03:35:24	800@192.168.0.9	910086	910086	
8	2014-06-16	03:27:44	800@192.168.0.9	910086	910086	
9	2014-06-16	03:27:39	800@192.168.0.9	910086	910086	
10	2014-06-16	03:20:03	800@192.168.0.9	910086	910086	
11	2014-06-16	02:20:53	800@192.168.0.9	915205188613	915205188613	

To Dial a call from Call History via phone interface:

1. Press History soft key or press Menu → History → Local history
2. Press and to select the targeted one.
3. Press the Send soft key, or , or , or the corresponding line key.

LDAP Phonebook

When use the LDAP feature, you can get the LDAP Phonebook directly.

To configure LDAP via web interface:

1. Login webpage and click Directory→LDAP
2. Filled the LDAP Name Filter:
 - a) This parameter specifies the name attributes for LDAP searching. The “%” symbol in the filter stands for the entering string used as the prefix of the filter condition.
 - b) For example (cn=%), when the name prefix of the cn of the contact record matches the search criteria, the record will be displayed on the IP PHONE LCD.
3. Filled LDAP Number Filter:

This This parameter specifies the number attributes for LDAP searching.
4. Filled Server Address: Fill the domain name or IP address of the LDAP Server.
For example: 192.168.0.124
5. Port(the port of the LDAP Serve) Base, User Name, Password
6. Max.Hits(1-32000): the maximum number of the search results to be returned by the LDAP server.
7. LDAP Display Name: the display name of the contact record displayed on the LCD screen.
8. Filled the relative value and then click save button the save the settings.

Following is the example screenshot for the configuration.

Directory | Remote Phone Book | Call History | LDAP | BroadSoft | Calllog | MultiCast Paging

LDAP Name Filter: (cn=%) ?

LDAP Number Filter: (|(telephoneNumber=%)) ?

Server Address: 192.168.0.9 ?

Port: 389 ?

Base: dc=HanLong, dc=com ?

User Name: cn=admin, dc=HanLong, d ?

Password: ●●●●●●●● ?

Max.Hits(1~32000): 32000 ?

LDAP Display Name: cn ?

Search Delay(0~2000ms): ?

Protocol: Version2 Version3 ?

LDAP Lookup For Incoming Call: On Off ?

LDAP Sorting Results: On Off ?

SaveSet Cancel

NOTE

To Configure LDAP Key

To configure LDAP Key via web interface:

1. Click Function Key→Memory Key→ choose Memory Key 1(for example)
2. Select LDAP in the Type field.
3. Click Saveset to save the configuration.

Line Key | Memory Key | Programmable Key | EXP KEY

Memory Key	Type	Value	Account	Pickup Code
Key1	LDAP		Account 1	
Key2	N/A		Account 1	
Key3	N/A		Account 1	
Key4	N/A		Account 1	
Key5	N/A		Account 1	
Key6	N/A		Account 1	
Key7	N/A		Account 1	
Key8	N/A		Account 1	
Key9	N/A		Account 1	
Key10	N/A		Account 1	

SaveSet Restart

NOTE

Key Type:
The free function key Type-Speed Dial,BLF,Key Event,Intercom,URL

BLF:
BLF setting require a phone restart

To Configure LDAP Key via phone interface:

1. Press Menu→Feature→Function Keys→Memory Keys as Function Keys→Memory Key 1
2. Select LDAP in the Type field
3. Press save or OK key to save the configuration.

When press the LDAP Key the LCD will display as following:



For More detail, please refer to [LDAP Notes](http://www.h-tek.com) on www.h-tek.com

Broadsoft Phonebook

You can access the BroadSoft directory through your phone. You can add local contacts from the BroadSoft directory. You can also dial a contact from the BroadSoft directory. You can configure your new phone to access up to 6 BroadSoft directories and every broadsoft directory support 100 contacts. Contact your system administrator for the access URL of the BroadSoft directory.

To Configure Broadsoft via web interface:

1. To click Directory→Broadsoft
2. Select the desired Broadsoft Item
3. Enter the Display name
4. Enter the Server, port, User and password
5. Click to save the configuration.

Directory

Remote Phone Book

Call History

LDAP

BroadSoft

Calllog

MultiCast Paging

BroadSoft Item: BroadSoft 1

Display Name: Broadsoft group

Server: http:xsp1.iop1.broadworks.net/com.broadsoft

Port:

User: 2154523254@as.iop1

Password: ●●●

SaveSet Cancel

NOTE

Call log

You can access the call log of the BroadSoft user through the IP phone. The call log contains call information such as remote party identification, time and date. You can check the call log and dial a call from the call log list. The BroadSoft call log allows users to view and dial the stored numbers in the following lists: missed, received, and placed. You can configure the IP phone to access up to 3 call log items and every call log item support 100 contacts. Contact your system administrator for the access URL of the BroadSoft call log.

To Configure Call log via web interface:

1. To click Directory→Call log
2. Select the desired Call log Item
3. Enter the Display name
4. Enter the Server, port, User and password
5. Click to save the configuration.

Other features settings

Dial Plan

Dial plan is a string of characters that governs the way this phone processes the inputs received from your phone keypad. This phone supports dial plan with following accept digits:

1,2,3,4,5,6,7,8,9,0,*,#

Grammer	Description
x	any digit from 0-9;
XX+	at least 2 digit number;
^	exclude;
,	hear dial tone;
[3-5]	any digit of 3, 4, or 5;
[147]	any digit 1, 4, or 7;
<2=011>	replace digit 2 with 011 when dialing.

To configure dial plan via web interface:

1. Click Account—Advanced—Dial Plan.
2. Filled the value in dial plan field.

3. Click **SaveSet** to save the configuration.

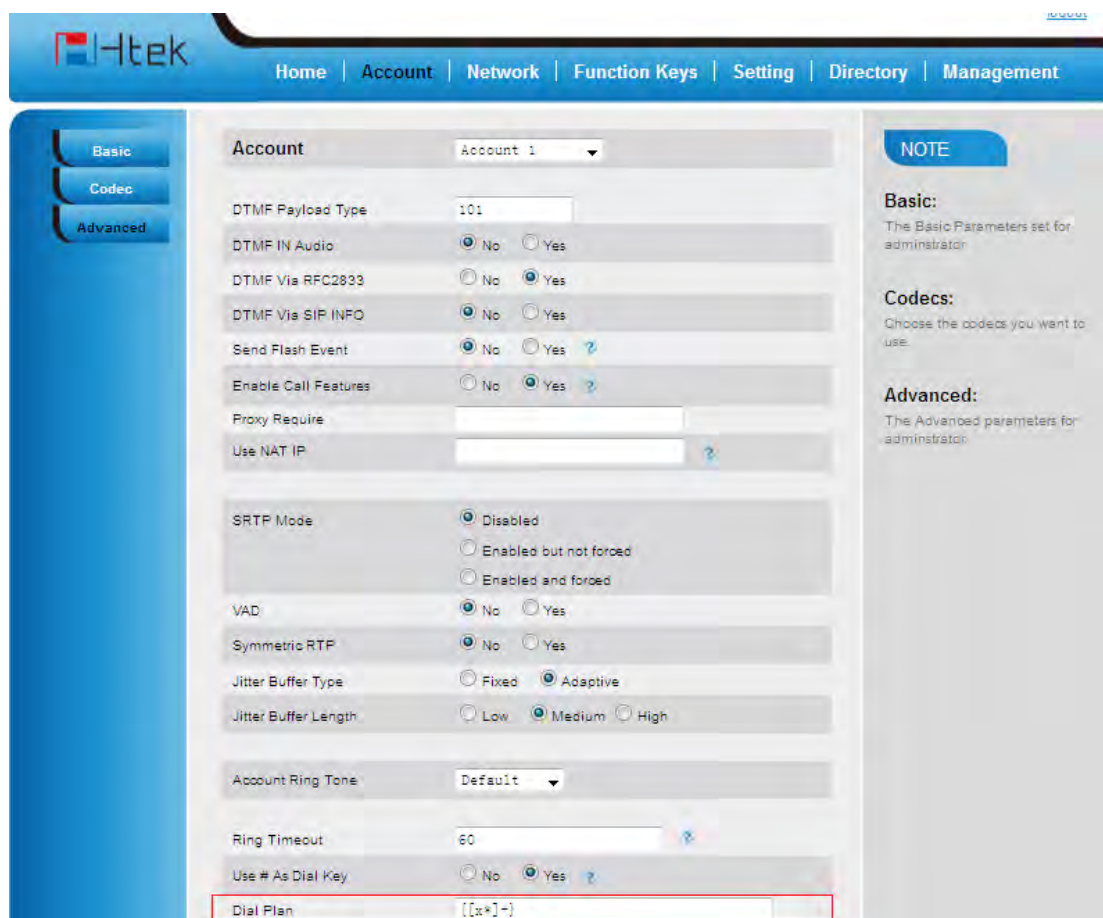

The screenshot shows the Htek web interface for configuring an account. The 'Account' section is selected, and the 'Dial Plan' field is highlighted with a red box. The value in the field is '[[x*]+]'. The page includes a navigation menu with 'Home', 'Account', 'Network', 'Function Keys', 'Setting', 'Directory', and 'Management'. A sidebar on the left has 'Basic', 'Codec', and 'Advanced' tabs. A 'NOTE' section on the right provides information about the configuration parameters.

Note:

Illegal input will fall back to default: `[[x*]+]`. For More, please refer to [dial plan](http://www.h-tek.com) on www.h-tek.com

Emergency Call

Public telephone networks in countries around the world have a single emergency telephone number (emergency services number), that allows a caller to contact local emergency services for assistance when required. The emergency telephone number may differ from country to country. It is typically a three-digit number so that it can be easily remembered and dialed quickly. Some countries have a different emergency number for each of the different emergency services.

You can specify the emergency telephone numbers on the IP phone for contacting the emergency services in an emergency situation.

To configure emergency call via web interface:

1. Click Setting→Features→Phone Lock
2. Enter the emergency services number in the Emergency field

3. Click **SaveSet** to save the configuration.

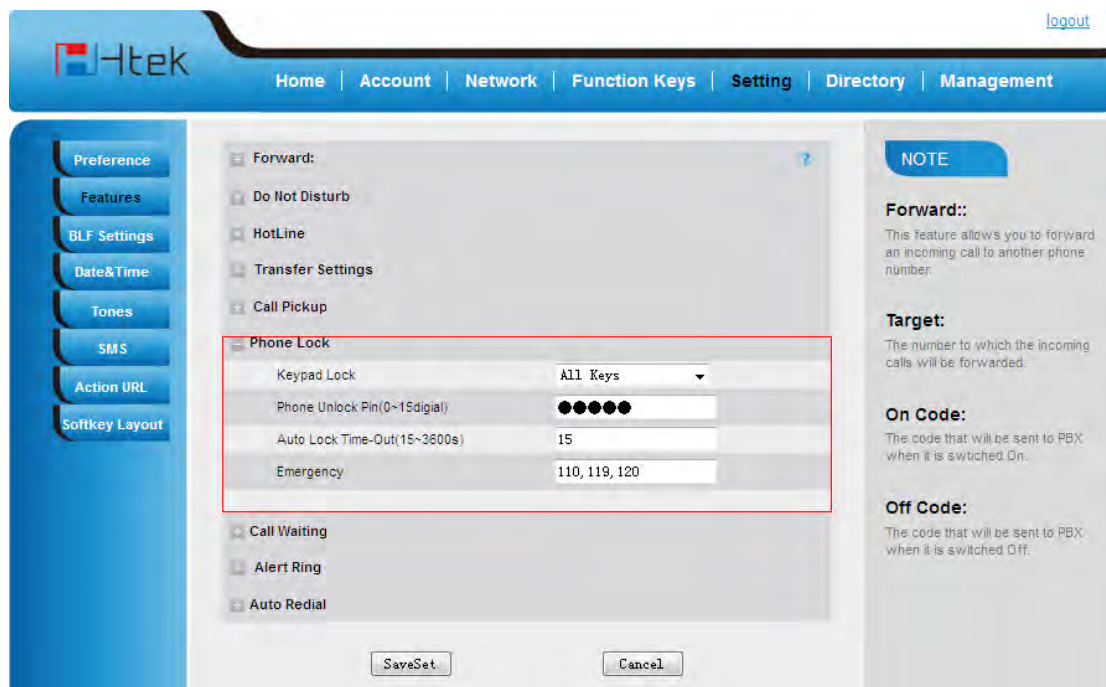

LED Status Setting

The LED Status setting mainly defines the power indicator LED.

To configure LED Status via web interface:

1. Click Setting → Preference
2. Select Yes or No for Power Status, Ringing Status, Miss Calls Status and Voice Message Status.
3. Click **SaveSet** for the setting.

For the LED status description, see: LED Instruction [Power Indicator LED](#)

LED Status Setting:

Power Status	<input checked="" type="radio"/> Yes	<input type="radio"/> No
Ringing Status	<input checked="" type="radio"/> Yes	<input type="radio"/> No
MissCalls Status	<input type="radio"/> Yes	<input checked="" type="radio"/> No
Voice Message Status	<input type="radio"/> Yes	<input checked="" type="radio"/> No

Action URL

To configure action url via web interface:

1. Click Setting→Action URL
2. Filled the needed value in the necessary blank.
3. Click to save the setting.

Click [Action URL](#) for more how to use, or check on www.h-tek.com

logout

Home | Account | Network | Function Keys | Setting | Directory | Management

Preference
Features
BLF Settings
Date&Time
Tones
SMS
Action URL
Softkey Layout





Setup Completed	<input type="text"/>	?
Log On	<input type="text"/>	?
Log Off	<input type="text"/>	?
Register Failed	<input type="text"/>	?
Off Hook	<input type="text"/>	?
On Hook	<input type="text"/>	?
Incoming Call	<input type="text"/>	?
Outgoing Call	<input type="text"/>	?
Call Established	<input type="text"/>	?
Call Terminated	<input type="text"/>	?
Open DND	<input type="text"/>	?
Close DND	<input type="text"/>	?
Open Always Forward	<input type="text"/>	?

NOTE

Softkey Layout

This feature mainly defines which shown on the soft key in some status. For example, what the soft key displays when dialing, or talking.

To configure Soft key via web interface:

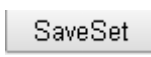
1. Click Setting→Softkey Layout
2. Select Enable for Custom Softkey
3. Select call States.
4. Select the feature form the disable key to enable key field by 
 Disable to Enable field.  Delete the Enable, and it will back to Disable field.
5. Click  or  to change to position or each feature.
6. Click  to save the configuration.

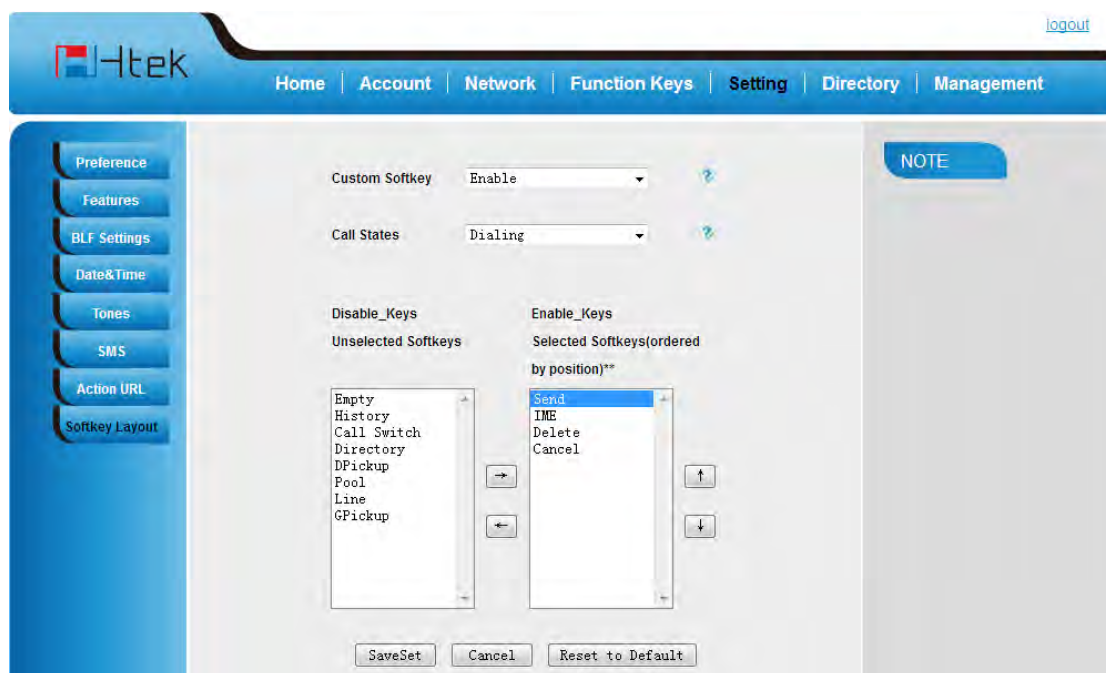
Note:

1. When there more than 5 items in the Enable field, the last softkey will display More, and last two item will show in the next page softkey, you can check by press more.

Programmable Key

For the default keys as Soft keys, Navigation keys and so on, you can define them as some specific feature, and it works only on the idle page.

To configure Programmable Key via web interface:

1. Click Function Keys → Programmable Keys
2. Select the desired Key to set.
3. Click to save the setting.
4. By clicking , all setting of the keys will be back to default.

The screenshot shows the Htek web interface for configuring Programmable Keys. The top navigation bar includes 'Home', 'Account', 'Network', 'Function Keys', 'Setting', 'Directory', and 'Management'. The left sidebar has 'Line Key', 'Memory Key', 'Programmable Key', and 'EXP KEY'. The main content area features two tables for key configuration and three buttons at the bottom: 'SaveSet', 'Restart', and 'Reset To Default'.

Key	Type	Label	Account	Value
SoftKey1	History		Account 1	
SoftKey2	Directory		Account 1	
SoftKey3	DND		Account 1	
SoftKey4	Menu		Account 1	

Key	Type	Account	Value
Up	History	Account 1	
Down	Directory	Account 1	
Left	Switch Account Up	Account 1	
Right	Switch Account Down	Account 1	
OK	Status	Account 1	
Cancel	N/A	Account 1	
MUTE	N/A	Account 1	
CONF	N/A	Account 1	
TRAN	Forward	Account 1	
HOLD	N/A	Account 1	

Ext Key

It only works when there is expansion module connected with the phone.



For Ext Key configuration, please refer to: [UC40 User manual](#).

Basic Call Features



Place a Call

There are three ways to dialing a call: Handset, Headset and Hands-free speakerphone.

To place a call by Handset

1. Pick up the handset, or press a line key and dial the necessary number.
2. Press  or  or press the send softkey, then the call is sending.

To place a call by Headset:



1. Press the  (light is Green),
2. Enter the desired number.
3. Press  or , or press the Send softkey, then the call is sending.

Using headset to place and answer calls for all time





1. Click webpage Setting →Preference
2. HeadSet Priority →Enable
3. Ring Device For HeadSet →User Headset
4. Press 

Refresh Caller Id Via Contact	Disable
HeadSet Priority	Enable
Ringer Device For HeadSet	Use Speaker
Redial Mode	<input checked="" type="radio"/> Direct Mode <input type="radio"/> Select Mode
Intercom Barge	<input type="radio"/> On <input checked="" type="radio"/> Off ?
Show Missed Calls	<input checked="" type="radio"/> Yes <input type="radio"/> No ?
Suppress DTMF Display	<input type="radio"/> Off <input checked="" type="radio"/> On
Suppress DTMF Display Delay	<input type="radio"/> Off <input checked="" type="radio"/> On
Voice Mail Tone	<input checked="" type="radio"/> On <input type="radio"/> Off
Busy Tone Timer (0~5s)	4

Placing a call by hands-free speakerphone

1. Press the , or press the Line key, then you can hear the dial tone.
2. Press the number.
3. Press  or  press the Send soft key, then the call is sending.

To place a call by call history or Directory via phone interface.

1. Press the History soft key (On the idle page) or Menu → History /Directory
2. Press  and  to select the targeted one.
3. Press the Send soft key, or , or , or the corresponding line key, then the call is sending.

Note:

1. The  key is set to be a send key. For more information, refer to the Key as Send on page
2. During the call, you can also change among Headset, Handset or Free-speaker mode.

Making two calls with one line and one account

1. Press a line key and dial one phone number, then make a call.

2. Press the corresponding line key
3. Dial another phone number,
4. Press the Send soft key, or , then make the second call.



End a Call

Here shows to end a call during three modes:



To end a call by Handset

Press the Cancel soft key or hang up the handset, or press .

To end a call under Headset Mode

Press the Cancel soft key or press , or press .

To end a call under hands-free speakerphone Mode

Press the Cancel soft key or press , or press .

Note:

1. During the conference, to end the call is same as mentioned above.

Redial a Call

To redial the last placed call from the IP Phone

Press  directly when LCD is on the idle interface.

Receive a Call

There are three ways to receive a call when the phone is ringing:

To receive a call by handset

Pick up the handset the conversation is built.

To receive a call by headset

Press  and now the conversation is built.

To receive a call by hands-free speaker

1. Option 1: Press  directly.
2. Option 2: Press Answer soft key.
3. Option 3: Press the Line key (flashes red).

Moreover, some other action can be done by soft key when the call is coming.

1. To press the Reject soft key to reject the call. Or press  to reject the current call.
2. To press Forward to forward to another phone.
3. To press Silence soft key, and then the call will keep silent, no ring tone display.

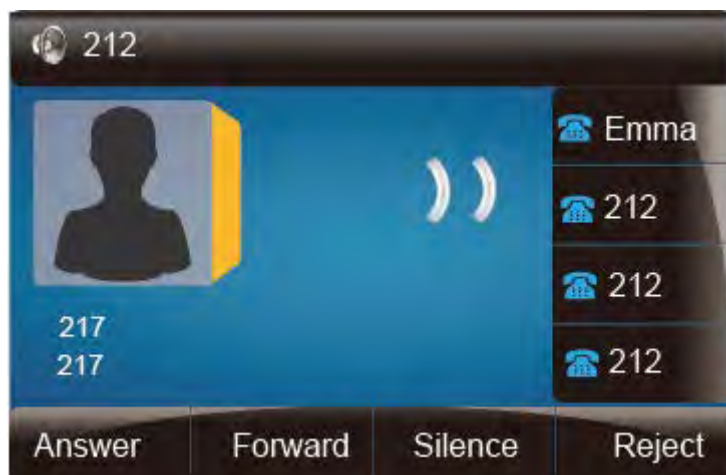

Incoming Call Show Mode

There are two incoming call show modes for this phone:

1. name and number of the contacts
2. name and number of the incoming call and the account which is connecting

To set incoming call show mode via web interface:

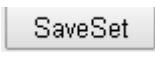
1. Click setting → preference
2. Select the desire mode for the incoming call show mode
3. Click  to save the setting.

LED Status Setting:

Power Status	<input checked="" type="radio"/> Yes	<input type="radio"/> No
Ringing Status	<input checked="" type="radio"/> Yes	<input type="radio"/> No
MissCalls Status	<input type="radio"/> Yes	<input checked="" type="radio"/> No
Voice Message Status	<input type="radio"/> Yes	<input checked="" type="radio"/> No

Incoming Call Show Mode	<input checked="" type="radio"/> Peer Name & Peer Number
	<input type="radio"/> Peer Name & Peer Number & Self Name

Auto Answer

Enable auto answer feature, you will answer all incoming call automatically.

To enable Auto Answer via Web interface

1. To Click Account → Advanced
2. To choose Yes for the Auto Answer.
3. To click Saveset to save the configuration.

Send Anonymous	<input checked="" type="radio"/> No	<input type="radio"/> Yes	?
Anonymous Call Rejection	<input checked="" type="radio"/> No	<input type="radio"/> Yes	
Check SIP User ID	<input checked="" type="radio"/> No	<input type="radio"/> Yes	
Auto Answer	<input type="radio"/> No	<input checked="" type="radio"/> Yes	
Allow Auto Answer By Call-Info	<input type="radio"/> No	<input checked="" type="radio"/> Yes	
Turn off Speaker on remote disconnect	<input type="radio"/> No	<input checked="" type="radio"/> Yes	
Session Expiration	<input type="text" value="180"/>	?	
Min-SE	<input type="text" value="90"/>	?	

To Disable Auto Answer via Webpage

1. To Click Account → Advanced
2. To choose No for the Auto Answer.
3. To click Saveset to save the configuration.

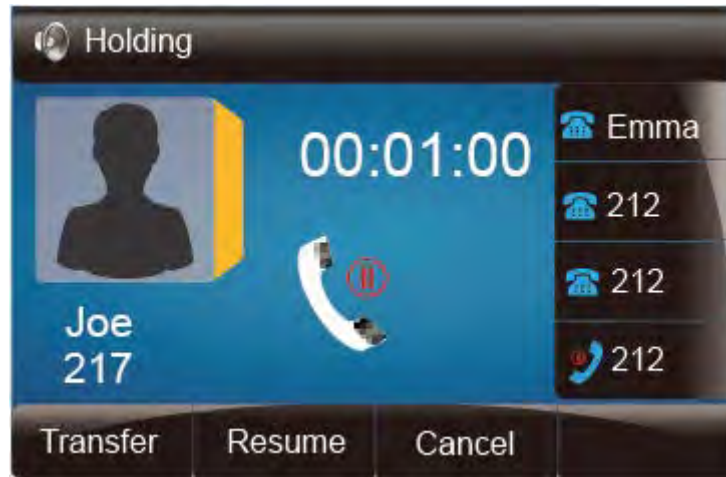

Call Hold

When use hold feature, the Hold icon will show on the display.





To make a call on hold during three modes:



To hold a call under handset mode:

1. Press Hold soft key or  to hold the current call.
2. Press Resume soft key or  to resume the call on hold.

To hold a call under headset mode:

1. Press Hold soft key or  to hold the current call.
2. Press Resume soft key or  to resume the call on hold.

To hold a call during the speaker mode:



1. Press Hold soft key or  to hold the current call.
2. Press Resume soft key or  to resume the call on hold.

Call Transfer

This phone supports blind, attended and Semi-Attended Transfer.

Blind Transfer

When you use this feature, you can transfer

1. Press  or Transfer soft key during the conversation, the call is on hold now.
2. Enter the number that transfers to.
3. Press , and now the blind transfer completed.

NOTE:



The “Enable Call Feature” must be configured to “Yes” to enable this feature (Account→Advanced).

Attended Transfer

When you use this feature, you can

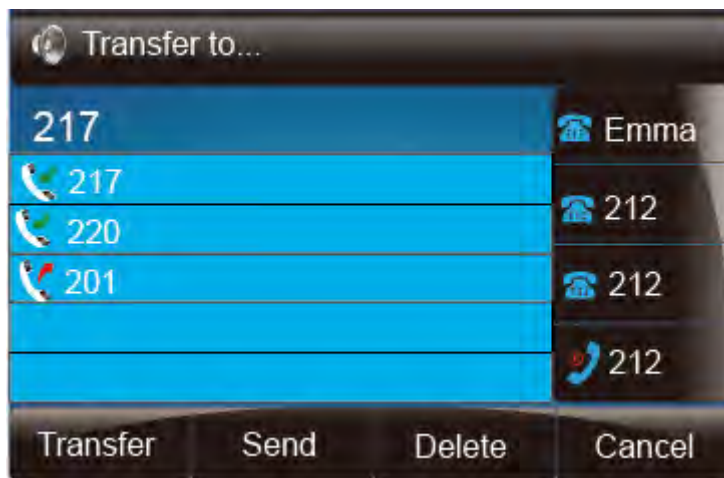
1. Press  or transfer soft key during the conversation, the call is on hold now.





2. Enter the number that transfer to, and press the send soft key or .
3. Start the second conversation, press  or transfer soft key, then, transfer completed.

NOTE:

To transfer calls across SIP domains, SIP service providers must support transfer across SIP domains. Blind transfer will usually use the primary account SIP profile.

Semi-Attended Transfer

1. Press  or transfer soft key during the conversation, the call is on hold now.
2. Enter the number transfer to, and then press , then you can here the ring tone.
3. Press  or the Tran soft key, and now the Semi-attended transfer completed.

BLF Transfer

1. Set a Programmable Key or line key is set as BLF. For how to set BLF, please refer to [BLF](#)
2. Press  or transfer soft key during the conversation, the call is on hold now.
3. Press BLF key then realize blind, attended and Semi-Attended Transfer.

Hold transfer on hook:

1. Setting → Features → Transfer Setting: Hold Transfer On Hook: ON.
2. A place a call to B, B answer, A press the hold softkey and place a call to C, A cancel the call when C is ringing or answering, then C and B in the same call and the transfer is successful.



Transfer to New Call via web interface

1. Click Setting → Feature
2. Select Transfer Mode via DSS key → New Call
3. Select the desired Line or Memory key and select Transfer in the Type.

4. Enter the phone number in the Value field.

Do Not Disturb
 HotLine
 Transfer Settings

Blind Transfer On Hook On Off
 Semi-Attended Transfer On Off
 Attended Transfer On Hook On Off

Transfer Mode via DSSkey
 Hold Transfer On Hook

Call Pickup
 Phone Lock

[logout](#)

[Home](#) | [Account](#) | [Network](#) | [Function Keys](#) | [Setting](#) | [Directory](#) | [Management](#)

Memory Key	Type	Value	Account	Pickup Code
Key1	BLF	530	Account 1	
Key2	N/A		Account 1	
Key3	N/A		Account 1	
Key4	N/A		Account 1	
Key5	N/A		Account 1	
Key6	N/A		Account 1	
Key7	N/A		Account 1	
Key8	N/A		Account 1	
Key9	N/A		Account 1	
Key10	N/A		Account 1	

NOTE

Key Type:
The free function key Type Speed Dial, BLF, Key Event, Intercom, URL.

BLF:
BLF setting require a phone restart.







NOTE: if the person that wanted to be spoken to do not want to answer the call, then the person that answered the coming call could use this function.

Call Conference

This IP Phone supports up to 5-way conference.

5-way conference

1. Assuming that call party A and B are in conversation. A wants to bring C, D and E in a conference

2. A press line 2 key, the call is placed on hold.
3. A enter the number of C and then press send soft key or .
4. C answering the call.
5. A press  or the conference soft key, then A, B and C are now in a conference.(and now this is **3-way conference**)
6. A press line 3 key, the current 3-way conference is placed on hold.
7. A enter the number of D and then press send soft key or .
8. D answering the call.
9. A press  or the conference soft key, then A, B, C and D are now in a conference.(and now this is **4-way conference**)
10. A press line 4 key, the call is placed on hold.
11. A enter the number of E and then press send soft key or .
12. E answering the call.
13. A press  or the conference soft key, then A, B, C, D and E are now the **5-way conference** is built.
14. A end the call, the conference is finished.



Note:

1. If C does not answer the call, A can back to continue the conversation with B;
2. Once A hangs up the call, the conference is ended, while if B or C drops the call, A&C or A&B conversation continues.
3. The conference feature is not available on all servers. For more information, contact your system administrator.
4. To realize the 5 way conference, the line should be all available.
5. Press  to get all parties information.

Call Forward



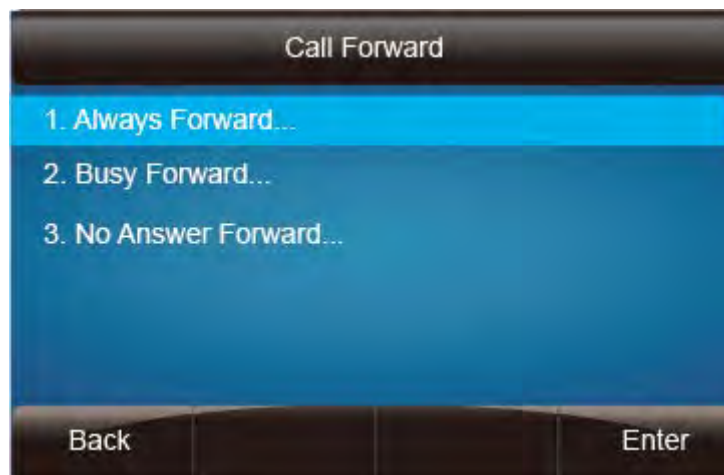

This phone supports static forward (always forward, busy forward and no answer forward) and dynamic forward



To configure static forward

To configure always forward



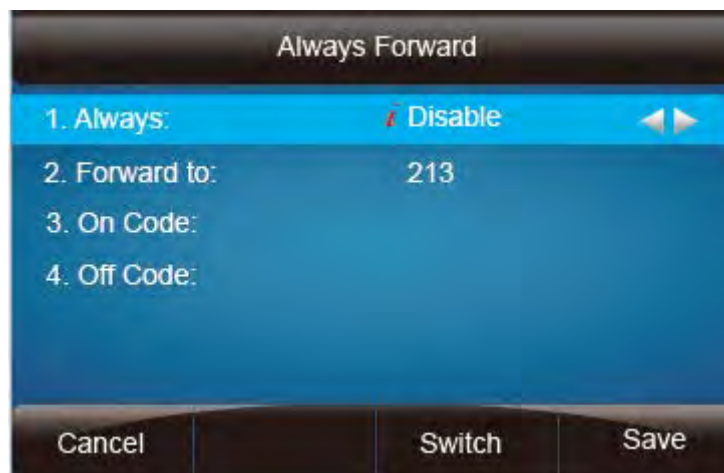

With this feature, all incoming calls will forward immediately to configured number.

1. Press Menu → Features → Call forward → Always Forward.
2. Press  and  or press  to select the enable choice
3. Enter the forward to number and on code (optional), off code (optional).
4. Press  or Save soft key to save the configuration.



To configure busy forward



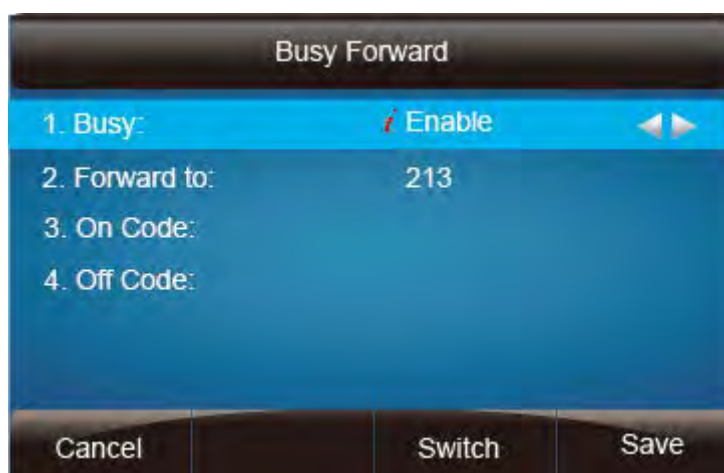

With this feature, the incoming calls are immediately forwarded if the phone is busy.

1. Press Menu → Features → Call forward → Busy forward.
2. Press  and  or press  to select the enable choice.
3. Enter the forward to number and on code (optional), off code (optional).
4. Press  or Save soft key to save the configuration.



To configure no answer forward

No Answer Forward: Incoming calls are forwarded if not answered after some time.

1. Press Menu → Features → Call forward → No answer forward.
2. Press  and  or press  to select the enable choice
3. Enter the forward to number and on code (optional), off code (optional).
4. Press  or Save soft key to save the configuration.

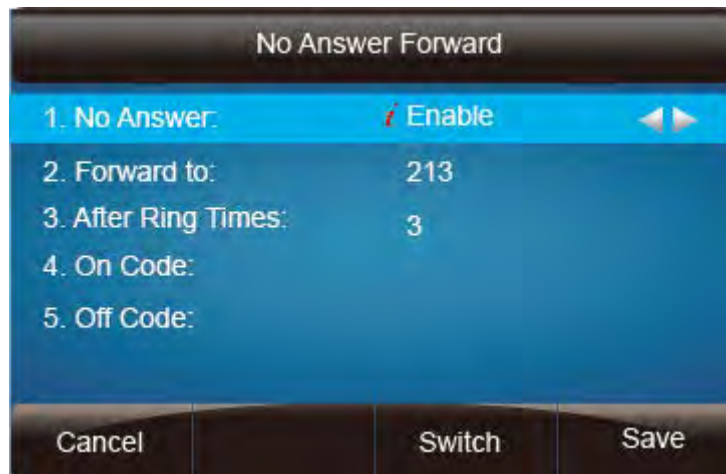

When the Forward feature is enabled, the Icon  will display on Top of the LCD.





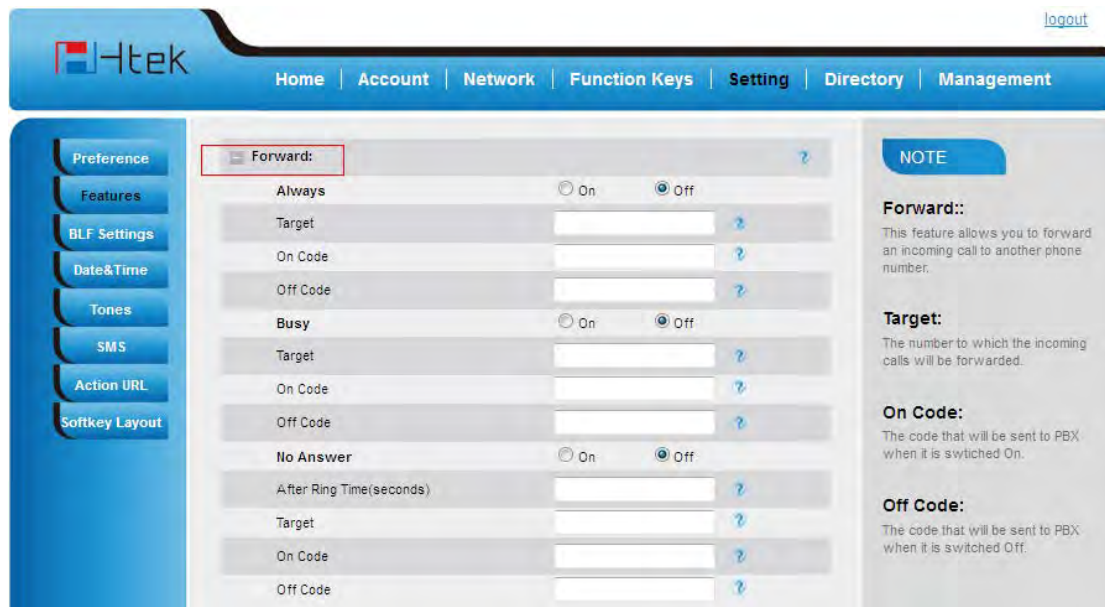

To configure Forward via Web Interface

1. Setting → Features
2. Click On for the Always/Busy/No Answer
3. Fill the Forward to Number

- (Optional) fill the on/off code
- Click  to save the configuration



To cancel the forward feature via Phone Interface

- Option 1: To press the  key to disable the forward feature.
- Option 2: Press Menu → Features → Call forward → Always/Busy/No answer Forward
 Press  and  or press  to select the disable choice
 Press  or Save soft key to save the configuration.

To cancel the forward feature via Web Interface

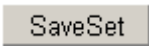
- Setting → Features
- Click Off for the Always/Busy/No Answer
- Click  to save the configuration

To configure dynamic forward

Forward an incoming call during the ringing.

1. When the phone is ringing, press Forward soft key.
2. Enter the forward number.
3. Press  or press the send soft key, then the call is forwarded.

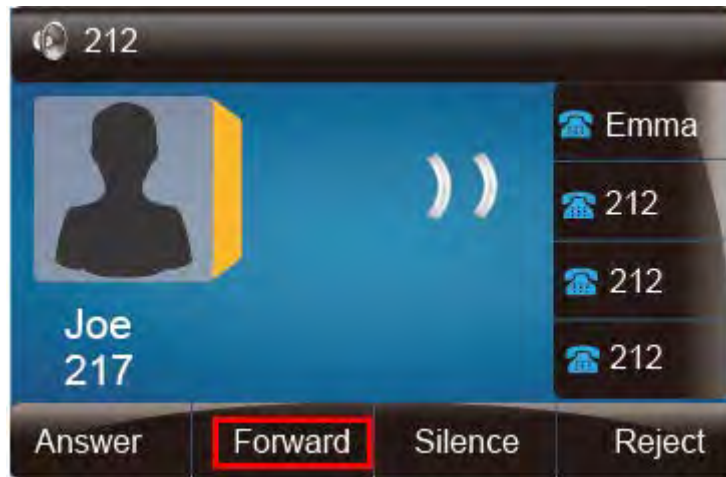







Note:

If the Programmable Key or line key is set as BLF, when an incoming call ringing, press this BLF key directly to realize the dynamic forward.

Call Return

This feature allows you to dial the last phone call you received.

To configure the Call Return via phone interface

1. Press Menu → Features → Function Keys → Line or Memory keys as Function Keys → Memory key1 (for example)
2. Select the wanted Line or Memory key.
3. Press  and  or press  key to select the Key Event in the type field.
4. Press  and  or press  key to select the Call Return.
5. Press  or Save soft key to save the configuration

To configure the Call Return via Web interface

1. Click Function keys → Line or Memory key.
2. Select the desired Line or Memory key and select Call Return in the Type.
3. Click the to save the configuration.

Call Waiting Tone

1. Click Setting → Features
2. Select Call Waiting: On and Call Waiting Tone: On

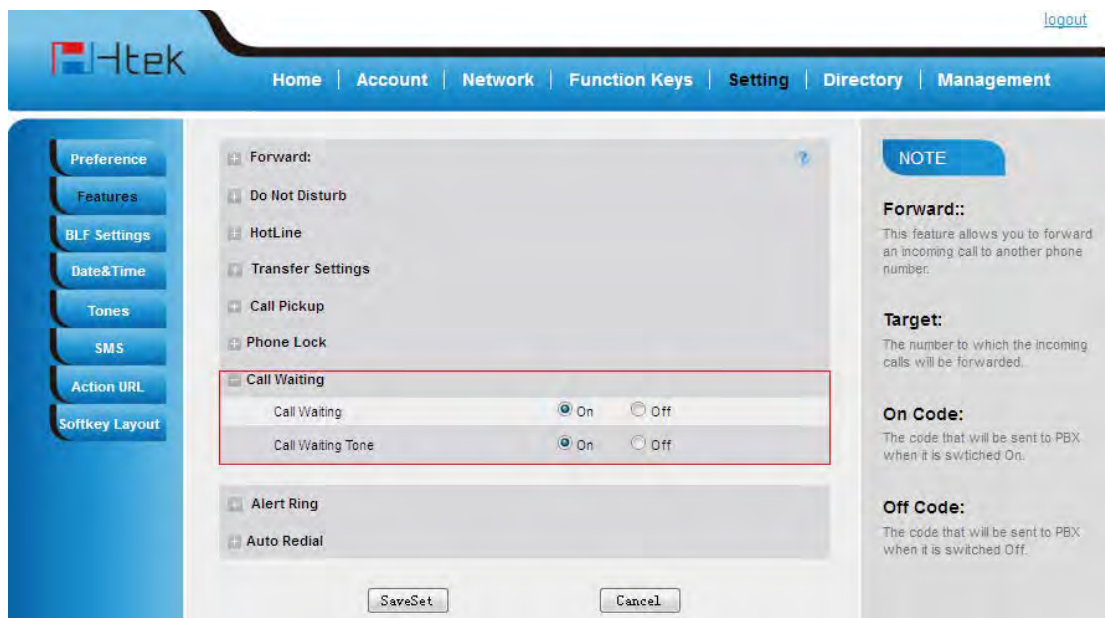

The screenshot shows the Htek web interface with the 'Setting' menu selected. The 'Call Waiting' section is highlighted with a red box, showing 'Call Waiting' and 'Call Waiting Tone' both set to 'On'. The 'SaveSet' button is visible at the bottom of the settings area.

NOTE

Forward::
This feature allows you to forward an incoming call to another phone number.

Target:
The number to which the incoming calls will be forwarded.

On Code:
The code that will be sent to PBX when it is switched On.

Off Code:
The code that will be sent to PBX when it is switched Off.

To Change the Call Waiting Tone time via Web interface

1. Click Setting → Tone

The screenshot shows the Htek web interface with the 'Setting' page selected. The 'Call Waiting Tone' field is highlighted with a red box. The field contains the code: f1=440@-13, c=300/10000-300/10000-0/0;.

2. Change the Tone Time as you want (for example 3s)

The close-up screenshot shows the 'Call Waiting Tone' field with the code: f1=440@-13, c=300/3000-300/3000-0/0;. The 'c=300/3000-300/3000-0/0;' part is highlighted with a red box.

Hide Caller ID



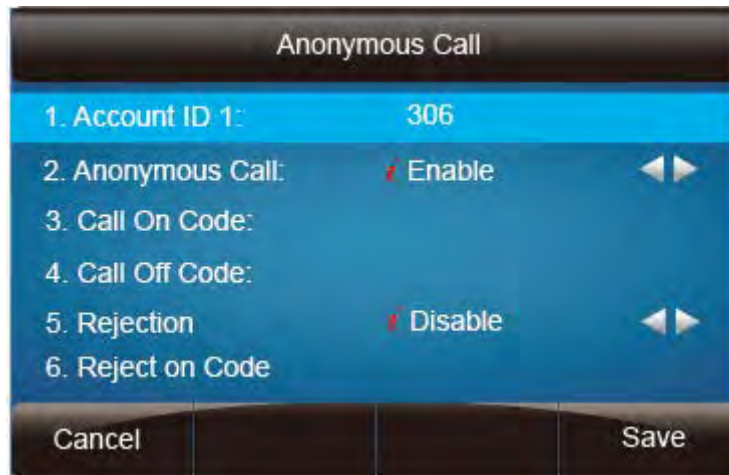

Just enable the anonymous call feature, you can set your ID do not appear on the other phone that you called.

To configure anonymous call

1. Press Menu → Features → Anonymous Call
2. Press and or press to change the Line ID
3. Press and or press to select the enable choice in Anonymous Call filed.
4. Enter the call on code (optional), call off code (optional).
5. Press or Save soft key to save the configuration.









To cancel anonymous call feature

1. Press Menu → Features → Anonymous Call
2. Press  and  or press  key to select the disable choice in Anonymous Call filed.
3. Press  or Save soft key to save the configuration.

Reject Anonymous

If you do not want to be disturb by anonymous calls, you can set the reject anonymous call features, so you will not hear the unknown calls

To configure rejecting anonymous call

1. Press Menu → Features → Anonymous Call
2. Press  and  or press  key to change the Line ID
3. Press  and  or press  key to select the enable choice in Rejection filed.
4. Press  or Save soft key to save the configuration

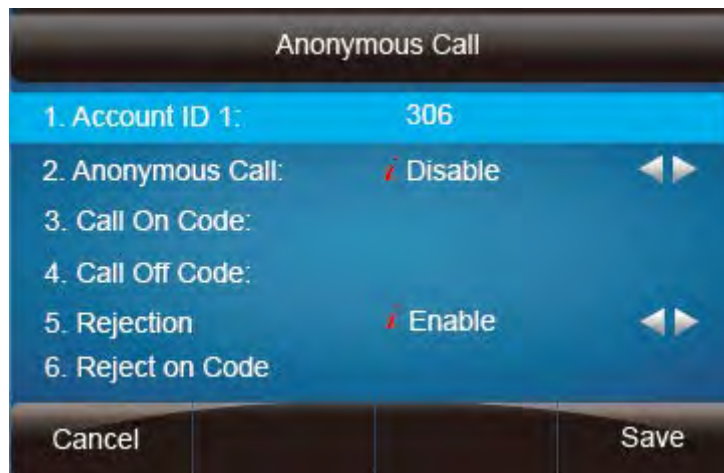

To cancel rejecting anonymous call



1. Press Menu → Features → Anonymous Call
2. Press and or press key to select the disable choice in Rejection filed.
3. Press or Save soft key to save the configuration.

Call Mute

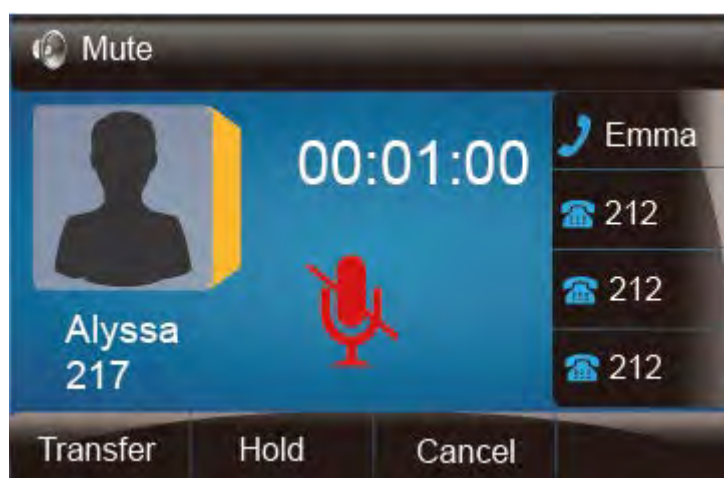
When you use the Mute feature, the other parties will not hear your voice while you can hear their voice. Call mute applies to all modes (handset, headset, and speakerphone).



To mute the call during a call (including a conference call)

1. Press the mute key , then the mute key glows green, and the LCD display 
2. To disable the mute function, press  again.

DND

When you use the DND feature, the phone is to reject all incoming calls automatically and you can see the mute icon  shown on the Top of the LCD on idle page.



To enable DND feature via phone interface:



Press the DND soft key when the phone is idle, and then  shown on the LCD.

To disable DND feature via phone interface:

Press the DND soft key again, and then there is no  on the LCD.

Key as Send



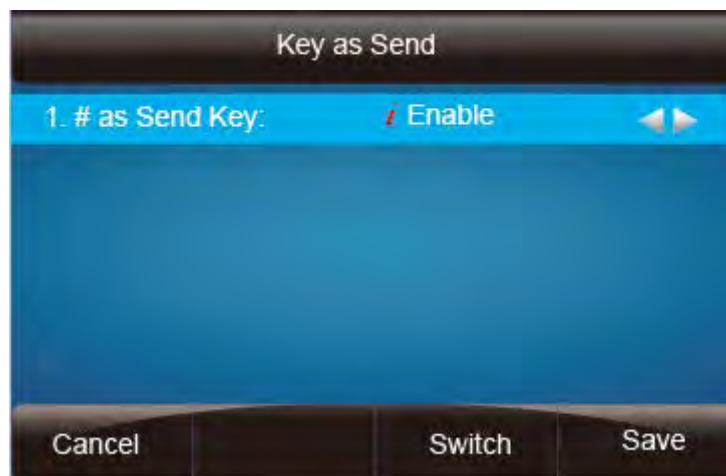

To configure Key as Send via phone interface:

1. Press Menu → Features → Key as Send
2. Press  and  or press  key to select the enable choice.

3. Press  or Save soft key to save the configuration



To cancel # Key as Send via phone interface:

1. Press Menu → Features → Key as Send
2. Press  and  or press  key to select the disable choice.
3. Press  or Save soft key to save the configuration

No Key Entry Timeout

No Key Entry Timeout means that when you enter the number, it will dial out automatically after some time when you stop enter the number.

To configure No Key Entry Timeout via web interface:

1. Click Webpage Setting → Preference
2. Fill the blank of No Key Entry Timeout: for example 5(seconds).(0 means never timeout, you should press the send key the dial out the number.
3. Click the  button to save the configuration.

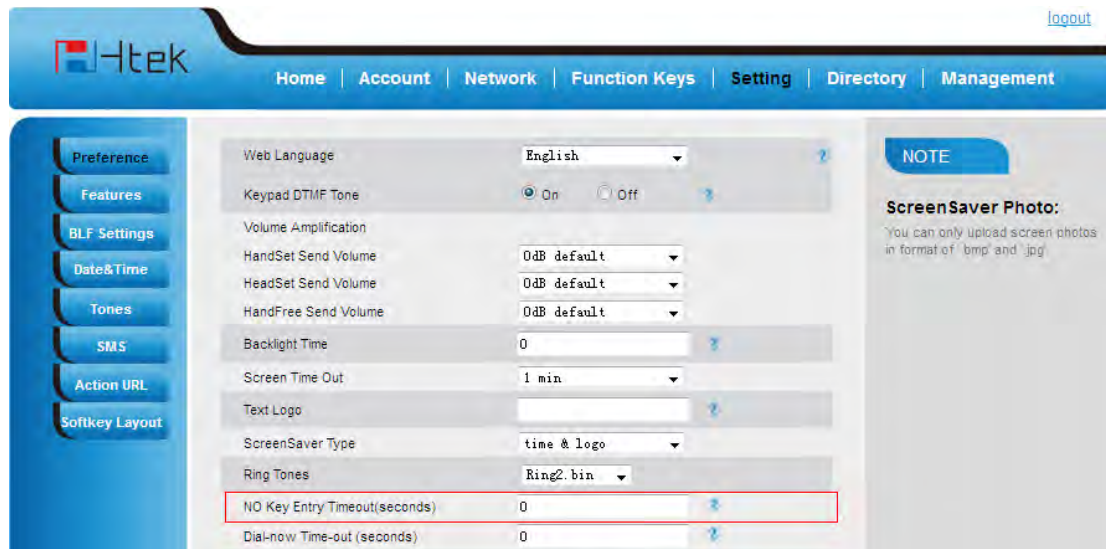

Keypad Lock

To enable Keypad Lock via Phone

1. Press Menu--Settings--Advanced Setting--Phone Setting--Lock
2. Press Info or Switch to change choose lock type: All Keys Menu Key Function Key Lock & Answer
3. Press Save or OK key to save the configuration.

To enable Keypad Lock via Phone

1. Press Menu--Settings--Advanced Setting--Phone Setting--Lock
2. Press Info or Switch to change to choose Off.
3. Press Save or OK key to save the configuration.

To enable Keypad Lock via Webpage

1. Click Webpage Setting → Features
2. To choose the Phone Lock.
3. To fill the unlock PIN and auto lock time
4. Fill the Emergence Number, when the phone is Lock, only Emergency Number can be sent.

5. To click  to save the configuration.

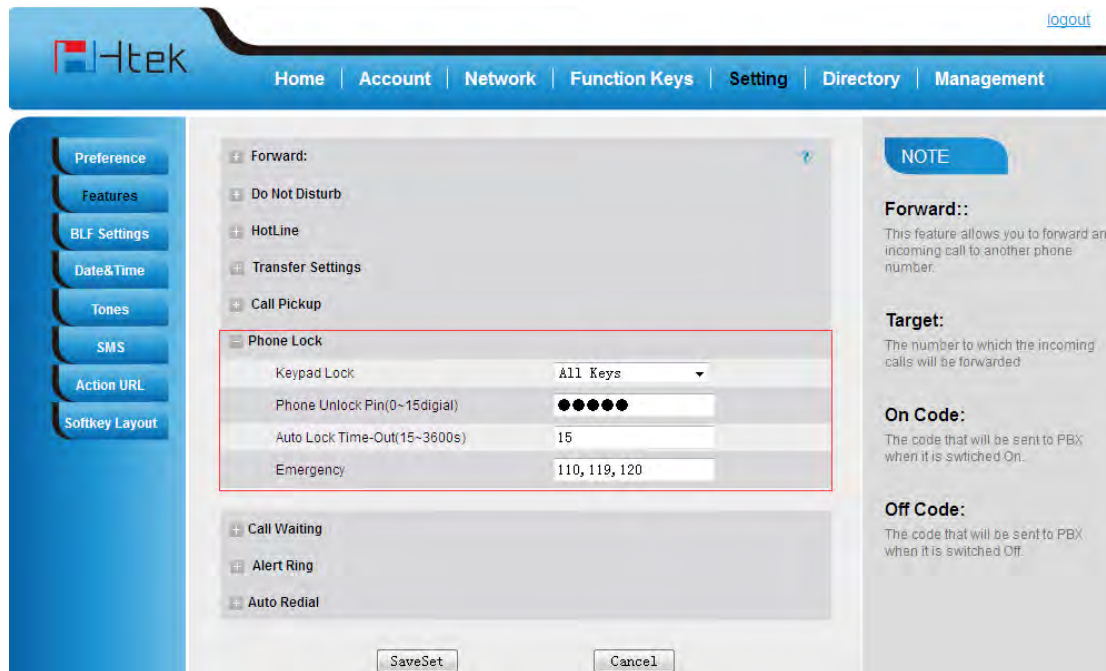

To Disable Keypad Lock via Webpage

1. Click Webpage Setting → Features
2. To choose Disable for the Phone Lock.
3. To click  to save the configuration.

Hot Line

To configure Hot Line

1. Press Menu → Features → Hot Line
2. Enter the Number and delay time (as present, we support off hook auto dial).
3. Press  or Save soft key to save the configuration

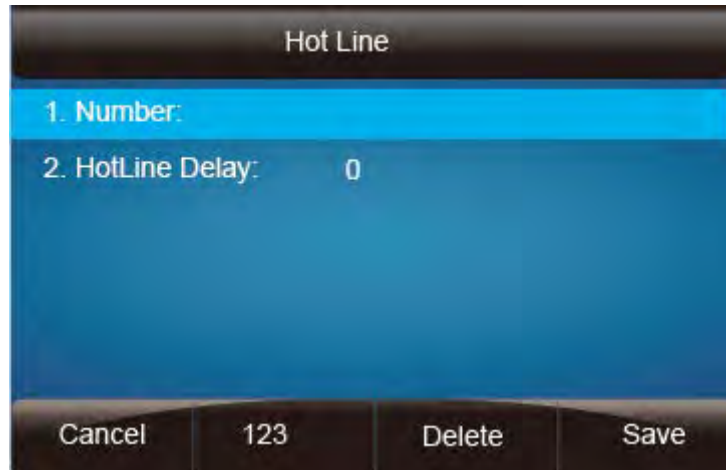

To configure Hotline auto dial via Web Interface

1. Setting → Features.
2. Fill the number in the Hotline Number and Hotline Time-out.
3. Click **SaveSet** to save the configuration.

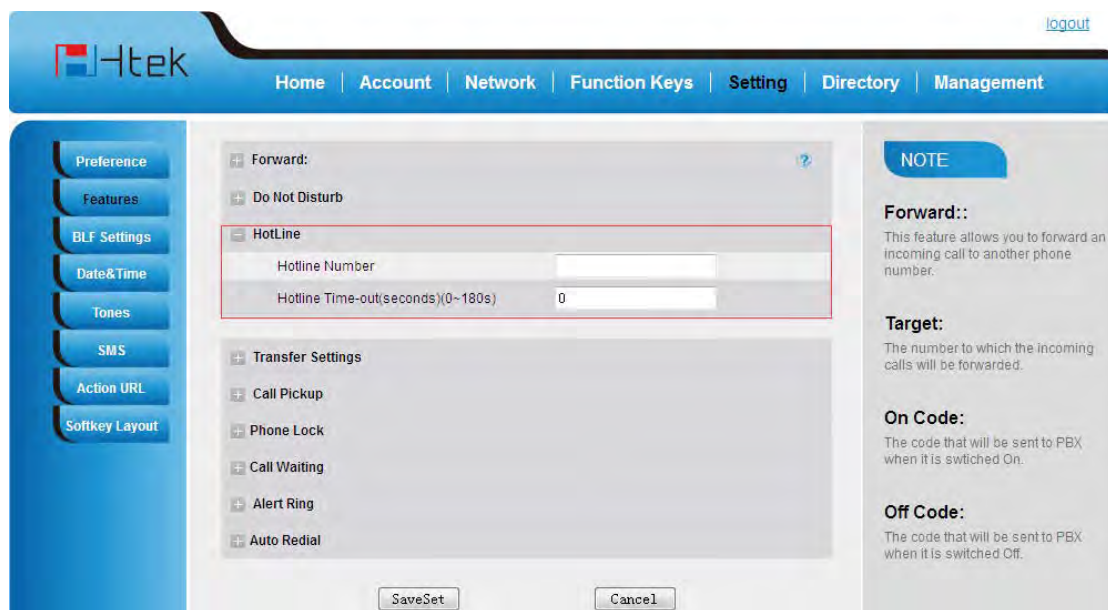

Delete the hotline number and save the configuration, and then now the Hotline auto dial is cancelled.

Function Key Features Settings

Line

It works same as Line keys.

To configure Line Feature via Web Interface

1. Click Function keys → Line or Memory Key.
2. Select the wanted Key and set as Line.
3. Select the Account.
4. Click the to save the configuration.

Memory Key	Type	Value	Account	Pickup Code
Key1	Line		Account 1	
Key2	N/A		Account 1	
Key3	N/A		Account 1	
Key4	N/A		Account 2	
Key5	N/A		Account 3	
Key6	N/A		Account 1	
Key7	N/A		Account 1	
Key8	N/A		Account 1	
Key9	N/A		Account 1	
Key10	N/A		Account 1	

NOTE

Key Type:
The free function key Type Speed Dial, BLF, Key Event, intercom, URL.

BLF:
BLF setting require a phone restart

Speed Dial

With this feature, you can dial one directory by press the definite key.

To configure Speed Dial feature via phone interface

1. Press Menu → Features → Function Keys → Line or Memory keys as Function Keys → Memory key1(for example)

2. Press and or press key to select the Speed Dial in the type field.
3. Enter the targeted Number.
4. Press or Save soft key to save the configuration

Then the selected Line or Memory key will work as Speed Dial.

To configure Speed Dial feature via Web Interface

1. Click Function keys → Line or Memory key.
2. Select the wanted Line or Memory key and set as Speed Dial.
3. Enter the desired phone number in the Value field.
4. Select the Account ID
5. Click the button to save the configuration.

Memory Key	Type	Value	Account	Pickup Code
Key1	Speed Dial	830	Account 1	
Key2	N/A		Account 1	
Key3	N/A		Account 1	
Key4	N/A		Account 2	
Key5	N/A		Account 3	
Key6	N/A		Account 1	
Key7	N/A		Account 1	
Key8	N/A		Account 1	
Key9	N/A		Account 1	
Key10	N/A		Account 1	

NOTE

Key Type:
The free function key Type Speed Dial, BLF, Key Event, Intercom, URL.

BLF:
BLF setting require a phone restart







BLF

You can use the BLF (Busy Lamp Field) feature to monitor a specific one whether his phone is

busy or free.

1. When the monitored line is idle, the light is steady green.
2. When the monitored line is ringing, the light is blinking red, press the BLF key to pick the phone up directly.
3. When the monitored line is calling or in a conversation, the light is steady red.

To configure a BLF key by phone

1. Press Menu → Features → Function Keys → Line or Memory keys as Function Keys → Memory key1 (for example).
2. Select the targeted Line or Memory key.
3. Press  and  or press  key to select the BLF in the type field.
4. Enter the targeted Value Number.
5. Press  and  or press  key to select the Account ID.
6. Enter the Pickup Code.
7. Press  or Save soft key to save the configuration

To configure a BLF key by web

1. Click Function keys → Line or Memory key.
2. Select the desired Line or Memory key and select BLF in the Type.
3. Enter the monitored phone number in the Value field.
4. Select the Account ID
5. Filled the Pickup code.
6. Click the  to save the configuration.

Memory Key	Type	Value	Account	Pickup Code
Key1	BLF	830	Account 1	**
Key2	N/A		Account 1	
Key3	N/A		Account 1	
Key4	N/A		Account 2	
Key5	N/A		Account 3	
Key6	N/A		Account 1	
Key7	N/A		Account 1	
Key8	N/A		Account 1	
Key9	N/A		Account 1	
Key10	N/A		Account 1	

NOTE

Key Type:
The free function key Type Speed Dial, BLF, Key Event, Intercom, URL.

BLF:
BLF setting require a phone restart

Note:

This feature is not available on all servers. For more information, contact your system administrator.

After setting the BLF key, do not need to restart the phone.

BLF List

To configure BLF List via web interface:

1. Login and click Account

Settings

* Account Active	<input type="radio"/> No <input checked="" type="radio"/> Yes	
* Primary SIP Server	<input type="text" value="as.iop2.broadworks.net"/>	?
Failover SIP Server	<input type="text"/>	?
Second Failover SipServer	<input type="text"/>	?
Prefer Primary SIP Server	<input checked="" type="radio"/> No <input type="radio"/> Yes	?
Outbound Proxy	<input type="text"/>	?
* SIP Transport	<input checked="" type="radio"/> UDP <input type="radio"/> TCP <input type="radio"/> TLS	?
NAT Traversal	<input type="radio"/> No <input checked="" type="radio"/> No, but send keep alive <input type="radio"/> STUN	
Lable	<input type="text"/>	?
* SIP User ID	<input type="text" value="2404984031"/>	?
* Authenticate ID	<input type="text" value="2404984031"/>	?
* Authenticate Password	<input type="password" value="....."/>	?
Name	<input type="text" value="4031"/>	?
DNS Mode	<input checked="" type="radio"/> A Record <input type="radio"/> SRV <input type="radio"/> NAPTR/SRV	

2. Click Advanced and then fill the Eventlist BLF URL.

Force Invite	<input checked="" type="radio"/> No <input type="radio"/> Yes	?
Hook Flash Timing	minimum: <input type="text" value="30"/> maximum: <input type="text" value="100"/>	?
Special Feature	<input type="text" value="Standard"/>	
Eventlist BLF URL	<input type="text" value="blf_sales"/>	

3. To configure BLF List Keys
 - 3.1 Click → Function Keys → Memory Key
 - 3.2 Select the BLF List in the Type Field.
 - 3.3. Select Account
 - 3.4 Click Saveset to save the configuration.

Settings

Key	Type	Value	Account	Pickup Code
Memory Key1	BLF List	2404984032	Account 4	**
Memory Key2	BLF List	2404984033	Account 4	**
Memory Key3	BLF List	2404984034	Account 4	**

For more information, please check [BLF list Note](#) on www.h-tek.com.

Voice Message

This phone supports Voicemail, and when there is message, the message will  will light green. Moreover, when pick up the handset, or press speaker key, you will hear some quick busy tone.

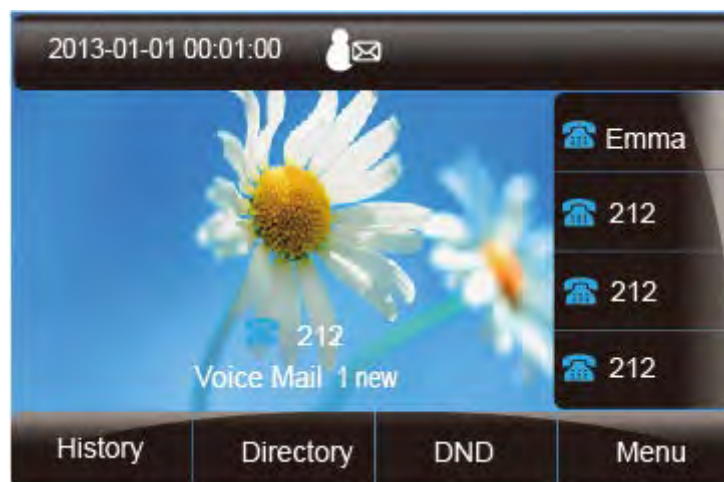

To configure the Voice mail feature via phone interface:





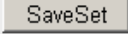

1. Press Menu → Messages → Voice Mail → Set Voice Mail.
2. Enter the Account1/2/3/4 NO.
3. Press  or Save soft key to save the configuration

To configure Voice Mail Memory Key via Web Interface:

1. Click Function keys → Memory Key.
2. Select the wanted Key.
3. Enter the desired voicemail feature codes in the Value field.

4. Filled the Label displayed on LCD.
5. Select the Account.
6. Click the  to save the configuration.

To configure a Voice mail key by phone interface:

1. Press Menu → Features → Function Keys → Line or Memory keys as Function Keys → Memory key1 (for example).
2. Select the targeted Line or Memory key.
3. Press  and  or press  key to select the Voice mail in the type field.
4. Enter the Value Number.
5. Press  and  or press  key to select the Account ID.
6. Press  or Save soft key to save the configuration



Note:

This feature is not available on all servers. For more information, contact your system administrator.

Direct Pickup

With this feature, you can pick up the set line when it ringing.

To configure Direct Pickup feature via phone interface

1. Press Menu → Features → Function Keys → Line or Memory keys as Function Keys → Memory key1 (for example)
2. Press  and  or press  key to select the Speed Dial in the type field.
3. Enter the value.

- Press  or Save soft key to save the configuration

Then the selected Line or Memory key will work as Direct Pickup.

To configure Direct Pickup feature via Web Interface

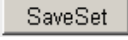
- Click Function keys → Line or Memory key.
- Select the wanted Line or Memory key and set as Direct Pickup.
- Enter the pickup code and followed the desired phone number in the Value field.
- Select the Account ID
- Click the  to save the configuration.

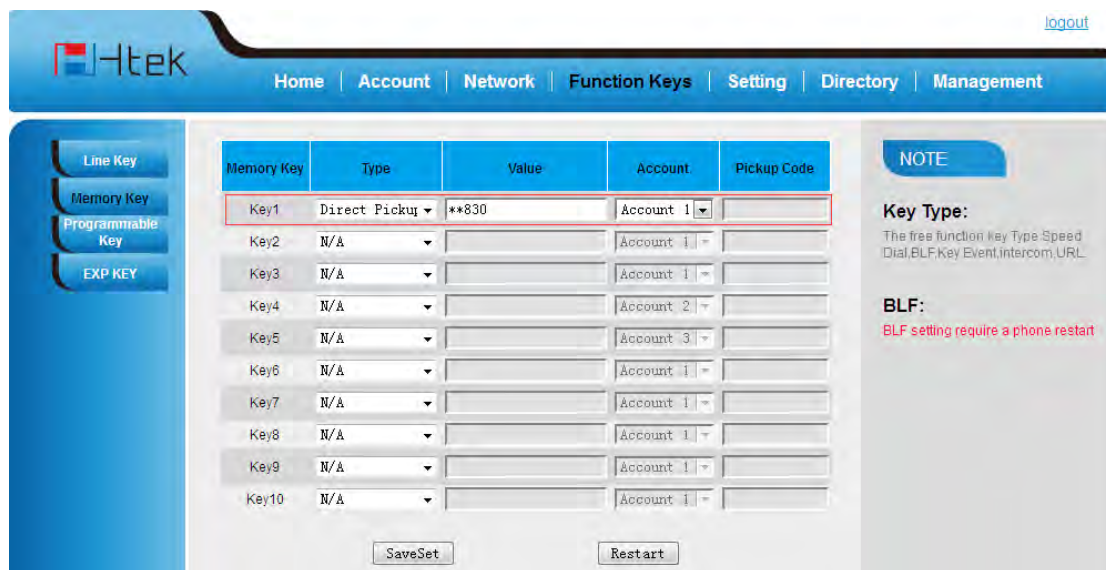

Memory Key	Type	Value	Account	Pickup Code
Key1	Direct Pickup	**830	Account 1	
Key2	N/A		Account 1	
Key3	N/A		Account 1	
Key4	N/A		Account 2	
Key5	N/A		Account 3	
Key6	N/A		Account 1	
Key7	N/A		Account 1	
Key8	N/A		Account 1	
Key9	N/A		Account 1	
Key10	N/A		Account 1	

NOTE

Key Type:
The free function Key Type:Speed Dial,BLF,Key Event,intercom,URL





BLF:
BLF setting require a phone restart

Group Pickup

With this feature, you can pick up the specified group that you want incoming calls.

To configure the Pick up via phone interface

- Press Menu → Features → Function Keys → Line or Memory keys as Function Keys → Memory key1 (for example)

2. Select the wanted Line or Memory key.
3. Press  and  or press  key to select the Group Pickup in the type field.
4. Enter pickup code and followed the desired group number
5. Press  or Save soft key to save the configuration

To configure the Group Pick up via Web interface

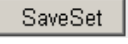
1. Click Function keys → Line or Memory key.
2. Select the desired Line or Memory key and select Group Pickup in the Type.
3. Enter the pickup code and followed the desired Group number in the Value field.
4. Click the  to save the configuration.

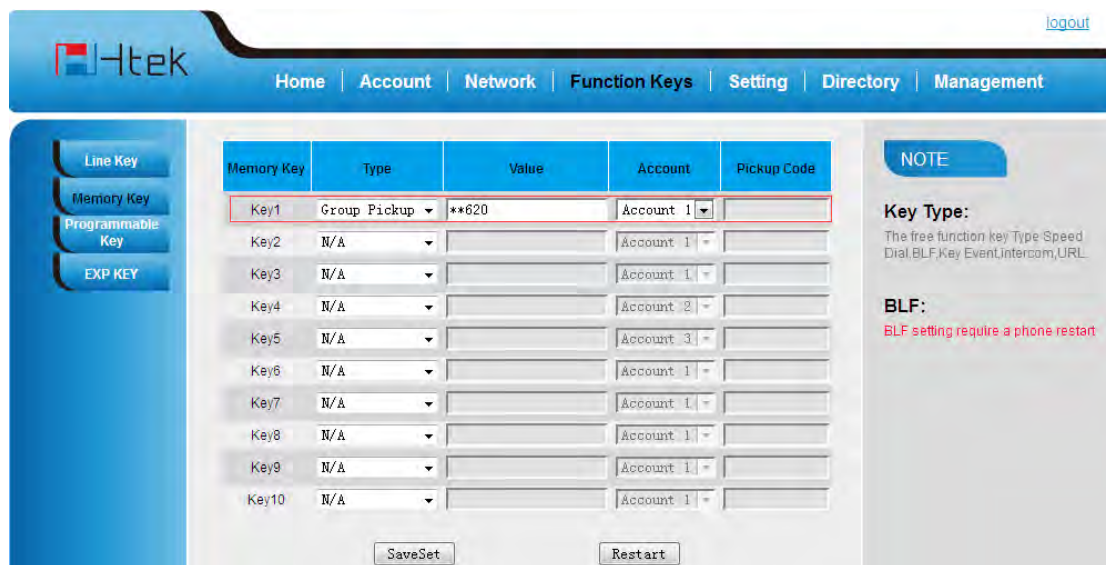

The screenshot shows the Htek web interface for configuring function keys. The top navigation bar includes Home, Account, Network, Function Keys, Setting, Directory, and Management. On the left, there are buttons for Line Key, Memory Key, Programmable Key, and EXP KEY. The main content area features a table with the following data:

Memory Key	Type	Value	Account	Pickup Code
Key1	Group Pickup	**620	Account 1	
Key2	N/A		Account 1	
Key3	N/A		Account 1	
Key4	N/A		Account 2	
Key5	N/A		Account 3	
Key6	N/A		Account 1	
Key7	N/A		Account 1	
Key8	N/A		Account 1	
Key9	N/A		Account 1	
Key10	N/A		Account 1	

At the bottom of the table, there are 'SaveSet' and 'Restart' buttons. On the right side, there is a 'NOTE' section with the following text:

Key Type:
The free function key Type Speed Dial, BLF, Key Event, Intercom, URL.



BLF:
BLF setting require a phone restart

Call Park

With this feature, you can put a call on hold and continue the conversation from another phone.

To configure the Call Park via phone interface

Settings

1. Press Menu → Features → Function Keys → Line or Memory keys as Function Keys → Memory key1(for example)
2. Press  and  or press Switch soft key to select the Call Park.
3. Press  or Save soft key to save the configuration

To configure the Call Park via Web interface

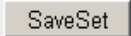
1. Click Function key → Line or Memory key.
2. Select the desired Line or Memory key and select call park in the Type.
3. Enter the call park code in the value field.
4. Click the  button to save the configuration.

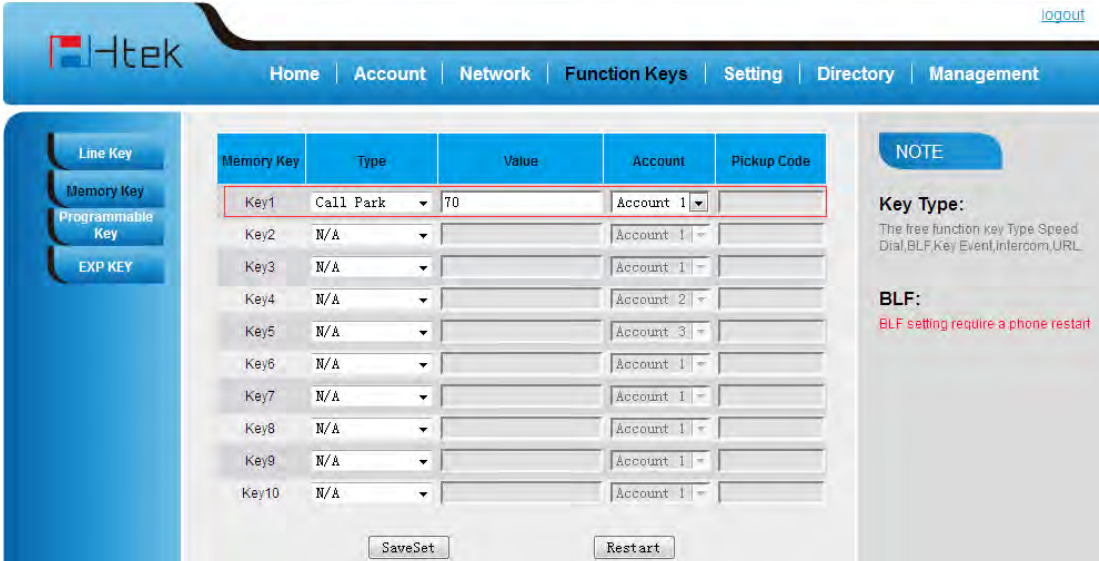

Memory Key	Type	Value	Account	Pickup Code
Key1	Call Park	70	Account 1	
Key2	N/A		Account 1	
Key3	N/A		Account 1	
Key4	N/A		Account 2	
Key5	N/A		Account 3	
Key6	N/A		Account 1	
Key7	N/A		Account 1	
Key8	N/A		Account 1	
Key9	N/A		Account 1	
Key10	N/A		Account 1	

NOTE

Key Type:
The free function key Type Speed Dial,BLF,Key Event,intercom,URL

BLF:
BLF setting require a phone restart





For More information for Call Park, please see: [Call park note](http://www.h-tek.com) on: <http://www.h-tek.com>

Intercom

When use the intercom feature, you can quickly get access connect to the configured one.

To configure intercom feature via phone interface

Settings

1. Press Menu → Features → Function Keys → Line or Memory keys as Function Keys → Memory key1 (for example)
2. Press  and  or press  key to select the intercom in the type field.
3. Enter the intercom codes followed by desired number.
4. Press  or Save soft key to save the configuration

Then the selected Line or Memory key will work as intercom.

To configure Intercom feature via Web Interface

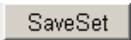
1. Click Function keys → Line or Memory key.
2. Select the wanted Line or Memory key.
3. Enter intercom codes followed by desired number in the Value field.
4. Select the Account ID
5. Click the  to save the configuration.

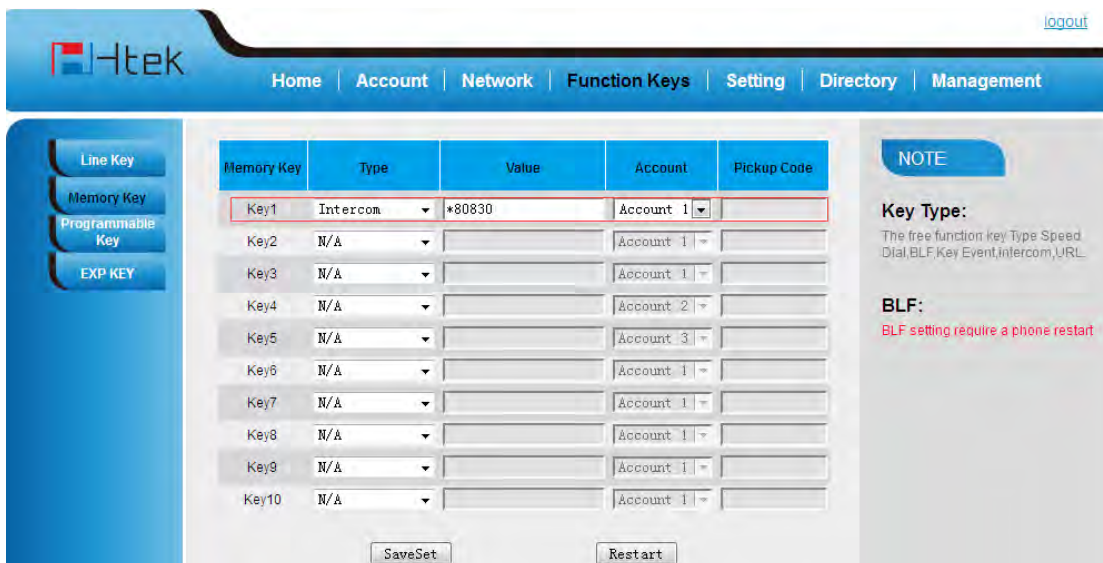

Memory Key	Type	Value	Account	Pickup Code
Key1	Intercom	+80830	Account 1	
Key2	N/A		Account 1	-
Key3	N/A		Account 1	-
Key4	N/A		Account 2	-
Key5	N/A		Account 3	-
Key6	N/A		Account 1	-
Key7	N/A		Account 1	-
Key8	N/A		Account 1	-
Key9	N/A		Account 1	-
Key10	N/A		Account 1	-

NOTE

Key Type:
The free function key Type Speed Dial, BLF, Key Event, intercom, URL.

BLF:
BLF setting require a phone restart

If you want to achieve the intercom feature, you must enable the “Allow Auto Answer By Call-Info”

1. Click the account
2. Select the desired account from the pull-down list of Account in the Account field.

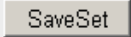
3. Click the advanced
4. Enable the “Allow Auto Answer By Call-Info”
5. Click the  button to save the configuration.

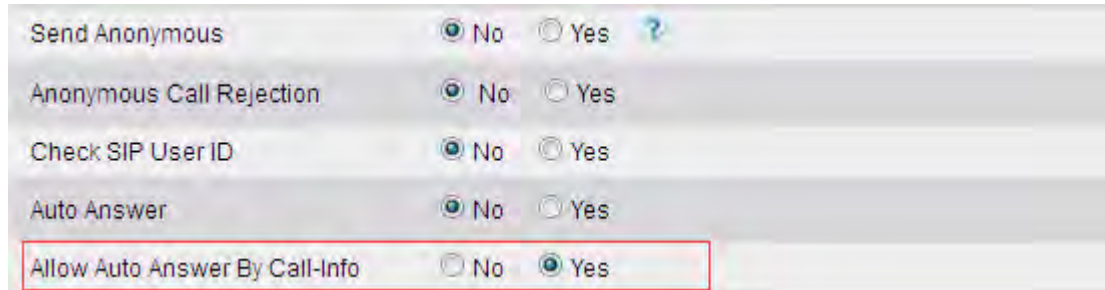
Note:

This feature is not available on all servers. For more information, contact your system administrator.

DTMF

When the key is configured as DTMF key, you are allowed to send out the desired DTMF number during the conversation.

To use this feature, you should sure that the DTMF Tone is on.

To configure the DTMF via Web Interface

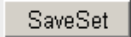
1. Click Setting→Preference
2. Select On for Keypad DTMF Tone.
3. Click the  to save the configuration.



To configure the DTMF via Phone Interface

1. Press Menu →Features →Function Keys→Line or Memory keys as Function Keys → Memory key1(for example)
2. Select the wanted Line or Memory key.

3. Press and or press key to select the DTMF in the type field.
4. Enter the value with the Desired DTMF number
5. Press or Save soft key to save the configuration

To configure the DTMF via Web interface

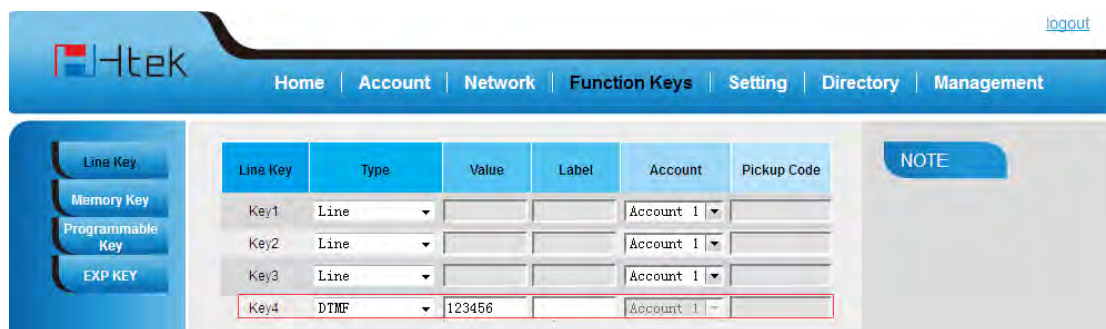
1. Click Function keys → Line or Memory key.
2. Select the desired Line or Memory key and select DTMF in the Type.
3. Fill the value with the Desired DTMF number.
4. Click the to save the configuration.



Prefix

If the key is configured as Prefix key, you can set the number prefix (e.g. Before the number plus 9), then you don't input 9, press the key and 9 will display on the LCD interface.

To configure the Prefix via Phone Interface

1. Press Menu → Features → Function Keys → Line or Memory keys as Function Keys → Memory key1 (for example)
2. Select the wanted Line or Memory key.
3. Press and or press key to select the Prefix in the type field.

4. Enter the value with with number that you want to set as prefix

5. Press  or Save soft key to save the configuration

To configure the Prefix via Web interface

1. Click Function key → Line or Memory key.
2. Select the desired Line or Memory key and select Prefix in the Type.
3. Fill the value.
4. Click the  to save the configuration.

Then when you press this key, the set value is input directly.

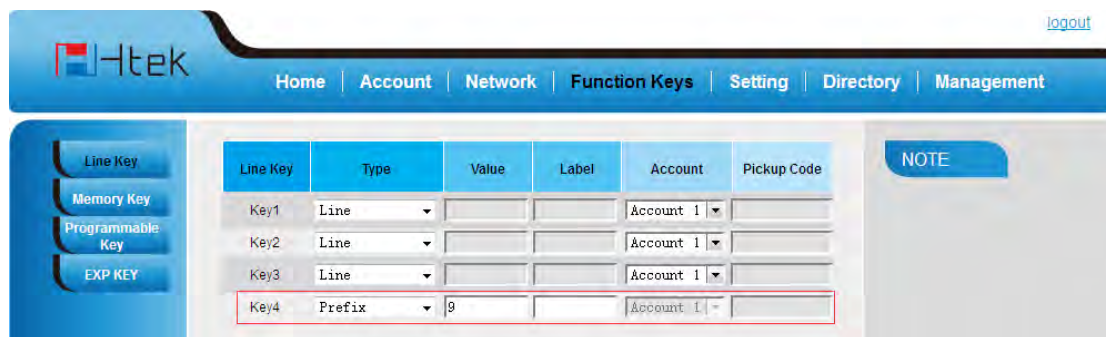



Line Key	Type	Value	Label	Account	Pickup Code
Key1	Line			Account 1	
Key2	Line			Account 1	
Key3	Line			Account 1	
Key4	Prefix	9		Account 1	

Local Group

When use the Local Group feature, press the key and enter the local Contacts interface quickly.

To configure the Local group via Phone Interface

1. Press Menu → Features → Function Keys → Memory keys as Function Keys → Memory key1 (for example)
2. Select the wanted Memory key.
3. Press  and  or press  key to select the Local group in the type field.

- Press or Save soft key to save the configuration

To configure the Local Group via Web interface

- Click Function key → Memory Key.
- Select the desired Key and select Local group in the Type.
- Click the **SaveSet** to save the configuration.

Then you can press the local group key to access the pre-defined contact group in the local directory quickly.

Memory Key	Type	Value	Account	Pickup Code
Key1	Local Group		Account 1	
Key2	N/A		Account 1	
Key3	N/A		Account 1	
Key4	N/A		Account 1	
Key5	N/A		Account 1	
Key6	N/A		Account 1	
Key7	N/A		Account 1	
Key8	N/A		Account 1	
Key9	N/A		Account 1	
Key10	N/A		Account 1	

XML Group

When use the XML Group feature, press the key and enter the Remote Contacts interface quickly.

To configure the XML group via Phone Interface

- Press Menu → Features → Function Keys → Memory keys as Function Keys → Memory key1 (for example)
- Select the wanted Memory key.
- Press and or press key to select the XML group in the type field.

4. Press or Save soft key to save the configuration

To configure the XML Group via Web interface

1. Click Function key → Memory Key.
2. Select the desired Key and select XML group in the Type.
3. Click the to save the configuration.

Memory Key	Type	Value	Account	Pickup Code
Key1	XML Group		Account 1	
Key2	N/A		Account 1	
Key3	N/A		Account 1	
Key4	N/A		Account 1	
Key5	N/A		Account 1	
Key6	N/A		Account 1	
Key7	N/A		Account 1	
Key8	N/A		Account 1	
Key9	N/A		Account 1	
Key10	N/A		Account 1	

NOTE

Key Type:
The free function key Type Speed Dial, BLF, Key Event, Intercom, URL.

BLF:
BLF setting require a phone restart

LDAP

When use the LDAP feature, you can get the LDAP Phonebook directly.

To configure the LDAP via Phone Interface

1. Press Menu → Features → Function Keys → Memory keys as Function Keys → Memory key1 (for example)
2. Select the wanted Memory key.
3. Press and or press key to select the LDAP in the type field.

4. Press or Save soft key to save the configuration

To configure the LDAP via Web interface

1. Click Function key → Memory Key.
2. Select the desired Key and select LDAP in the Type.
3. Click the to save the configuration.

Memory Key	Type	Value	Account	Pickup Code
Key1	LDAP		Account 1	
Key2	N/A		Account 1	
Key3	N/A		Account 1	
Key4	N/A		Account 1	
Key5	N/A		Account 1	
Key6	N/A		Account 1	
Key7	N/A		Account 1	
Key8	N/A		Account 1	
Key9	N/A		Account 1	
Key10	N/A		Account 1	

NOTE

Key Type:
The free function key Type-Speed Dial, BLF, Key Event, Intercom, URL

BLF:
BLF setting require a phone restart

XML Browser

You can use this key feature to access the Xml browser quickly. The Xml browser allows you to create custom services which meet your functional requirements on the server. You can customize practical applications, such as weather report, stock information, Google search, etc.

To configure the XML Browser via Phone Interface

1. Press Menu → Features → Function Keys → Memory keys as Function Keys → Memory key1 (for example)
2. Select the wanted Memory key.
3. Press and or press key to select the XML Browser in the type field.

4. Filled the access URL for xml browser
5. Press  or Save soft key to save the configuration

To configure the XML Browser via Web interface

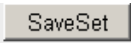
1. Click Function key → Memory Key.
2. Select the desired Key and select xml browser in the Type.
3. Filled the access URL for xml browser (e.g.http://192.168.0.240:8080/xmlbrowser/text.xml)
4. Click the  button to save the configuration.

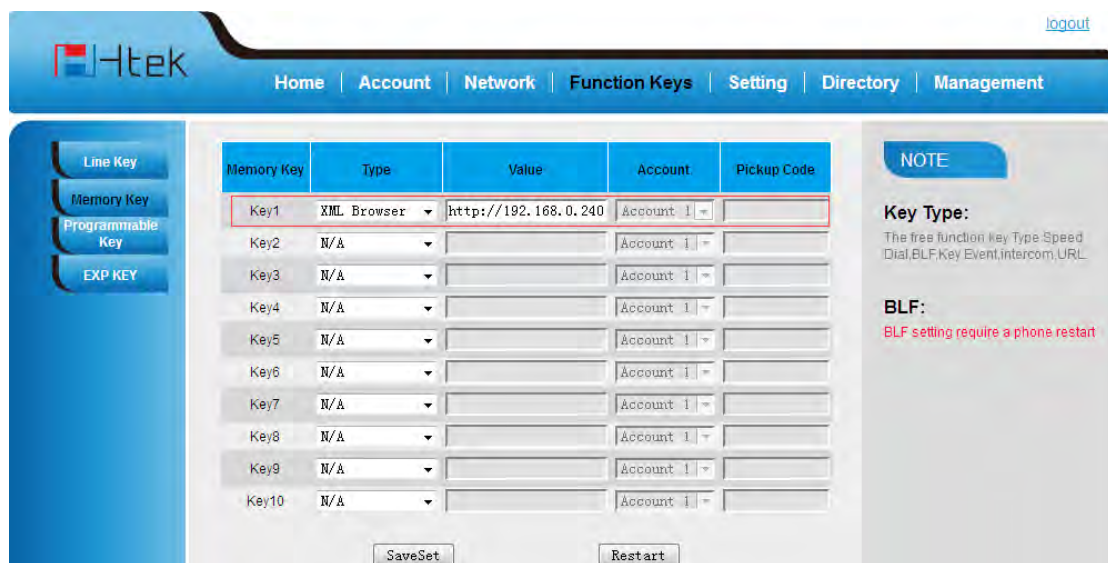





Broadsoft Group

When use the BroadSoft Group feature, press the key and enter the Remote Contacts interface quickly.

To configure the Broadsoft group via Phone Interface

1. Press Menu →Features →Function Keys→Memory keys as Function Keys → Memory key1(for example)
2. Select the wanted Memory key.

3. Press  and  or press  key to select the Broadsoft group in the type field.
4. Press  or Save soft key to save the configuration



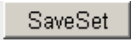

To configure the Broadsoft group via Web interface

1. Click Function key → Memory Key.
2. Select the desired Key and select Broadsoft group in the Type.
3. Click the  button to save the configuration.

Conference

The Htek IP Phone supports up to 5-way conference. You are allowed to configure the programmable key to be used as a conference key. This key works same as .

To configure the Conference via Phone Interface

1. Press Menu → Features → Function Keys → Memory keys as Function Keys → Memory key1 (for example)
2. Select the wanted Memory key.
3. Press  and  or press  key to select the Conference in the type field.
4. Press  or Save soft key to save the configuration



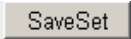

To configure Conference via Web Interface

1. Click Function keys → Memory Key.
2. Select the desired Key and select Conference in the Type.
3. Click the  button to save the configuration.

Forward

If the key is configured as Forward key, press this key under the idle status, the IP phone will turn to the Always Forward interface and you can set the Forward to number, then when there is any call to the number will be forwarded to the set number automatically.

To configure the Forward via Phone Interface

1. Press Menu → Features → Function Keys → Memory keys as Function Keys → Memory key1 (for example)
2. Select the wanted Memory key.
3. Press  and  or press  key to select the Forward in the type field.
4. Enter the Number that to forward.
5. Press  or Save soft key to save the configuration





To configure Forward via Web Interface

1. Click Function keys → Memory Key.
2. Select the desired Key and select Forward in the Type.
3. Enter the Value with the number you want to forward
4. Click the  button to save the configuration.

Transfer

You are able to configure the key as a transfer key to perform the Blind/Attended Transfer.

To configure the Transfer via Phone Interface

1. Press Menu →Features →Function Keys→Memory keys as Function Keys → Memory key1(for example)
2. Select the wanted Memory key.
3. Press  and  or press  key to select the Transfer in the type field.
4. Enter the Number that transfer to
5. Press  or Save soft key to save the configuration



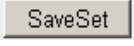

To configure Transfer via Web Interface

1. Click Function keys →Memory Key.
2. Select the desired Key and select Transfer in the Type.
3. Enter the Value with the number that wanted transfer to
4. Click the  button to save the configuration.

Hold

The key can be configured as a hold key. You can use this key to hold and resume a call during the conversation.

To configure the Hold via Phone Interface

1. Press Menu →Features →Function Keys→Memory keys as Function Keys → Memory key1(for example)
2. Select the wanted Memory key.
3. Press  and  or press  key to select the Hold in the type field.
4. Press  or Save soft key to save the configuration



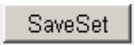

To configure Hold via Web Interface

1. Click Function keys →Memory Key.
2. Select the desired Key and select Hold in the Type.
3. Click the  button to save the configuration.

Group Listening

With this feature, when you active a call, you can listen using Handset and Free-speaker, but only can use the handset to speak.

To configure the Group Listening via Phone Interface

1. Press Menu →Features →Function Keys→Memory keys as Function Keys → Memory key1(for example)
2. Select the wanted Memory key.
3. Press  and  or press  key to select the group listening in the type field.
4. Press  or Save soft key to save the configuration

To configure Group listening via Web Interface



1. Click Function keys →Memory Key.
2. Select the desired Key and select Group listening in the Type.
3. Click the  button to save the configuration.

DND

If the key is configured as DND key, you are allowed to active the DND function immediately when you press it and the phone is to reject all incoming calls automatically. Press it again to

deactivate DND mode.

To configure the DND via Phone Interface

1. Press Menu → Features → Function Keys → Memory keys as Function Keys → Memory key1 (for example)
2. Select the wanted Memory key.
3. Press  and  key to select the DND in the type field.
4. Press  or Save soft key to save the configuration

To configure DND via Web Interface

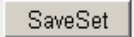
1. Click Function keys → Memory Key.
2. Select the desired Key and select DND in the Type.
3. Click the  button to save the configuration.

To enable DND feature

Press the DND soft key when the phone is idle status, and then DND icon shown on the LCD.

To disable DND feature

Press the DND soft key again, and then there is no DND icon on the LCD.

Redial

If the key is configured as Redial key, you can redial the last placed call from the IP Phone.

To configure Redial via Web Interface

1. Click Function keys → Line key/Memory key
2. Select the desired Key and select redial in the Type.
3. Enter the Label displayed on LCD.

- Click the **SaveSet** button to save the configuration.

SMS

Send SMS

To send SMS via web Interface

- Click Setting→SMS
- Select the account(from which account the SMS sent)
- Enter the target number
- Input the content of SMS, and click Send.

The screenshot shows the Htek web interface for sending SMS. The top navigation bar includes Home, Account, Network, Function Keys, Setting (highlighted), Directory, and Management. A sidebar on the left lists various settings: Preference, Features, BLF Settings, Date&Time, Tones, SMS (highlighted), Action URL, and Softkey Layout. The main content area contains a form with the following fields: Account (dropdown menu showing 'Account 1'), Number (text input with '832'), and Message (text area with 'Where are you?'). Below the form are 'Send' and 'Cancel' buttons. A 'NOTE' box on the right states: 'SMS Number: Input the phone number which you are going to send message to.' A 'logout' link is visible in the top right corner.





To send SMS via phone interface:

- Click Menu→Message→Text Message→Set SMS
- Enter the contents in the white field.
- Press the save button
- Select the account (from which account the SMS sent)
- Enter the target number (to which account the number sent)

6. Press the Send button.

Set SMS Memory Key

To configure the SMS via Phone Interface

1. Press Menu → Features → Function Keys → Memory keys as Function Keys → Memory key1 (for example)
2. Select the wanted Memory key.
3. Press  and  or press  key to select the SMS in the type field.
4. Press  or Save soft key to save the configuration





To configure SMS via Web Interface

1. Click Function keys → Memory Key.
2. Select the desired Key and select SMS in the Type.
3. Click the  to save the configuration.

Record

With record feature, you can record calls by pressing a record key on the phone.

To configure the record via phone interface

1. Press Menu → Features → Function Keys → Line or Memory keys as Function Keys → Memory key1 (for example)
2. Select the wanted Line or Memory key.
3. Press  and  or press  key to select the Record.
4. Press  or Save soft key to save the configuration

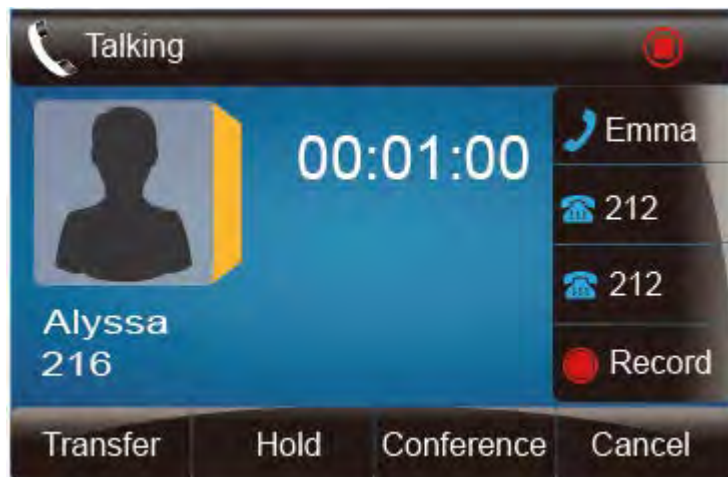

To configure the record via Web Interface

1. Click Function keys → Line or Memory key.
2. Select the desired Line or Memory key and select Record in the Type.
3. Click the button to save the configuration.

Memory Key	Type	Value	Account	Pickup Code
Key1	Record		Account 1	
Key2	N/A		Account 1	
Key3	N/A		Account 1	
Key4	N/A		Account 1	
Key5	N/A		Account 1	
Key6	N/A		Account 1	
Key7	N/A		Account 1	
Key8	N/A		Account 1	
Key9	N/A		Account 1	
Key10	N/A		Account 1	

NOTE

Key Type:
The free function key Type (Speed Dial, BLF, Key Event, Intercom, URL)

BLF:
BLF setting require a phone restart

Note:





Please contact the system administrator whether support this feature or not.

URL Record

The phone sends HTTP URL request to trigger a recording. Contact your system administrator for

the predefined URL.

To configure the URL record via phone interface

1. Press Menu → Features → Function Keys → Memory keys as Function Keys → Memory key1 (for example)
2. Select the wanted Line or Memory key.
3. Press  and  or press  key to select the URL Record.
4. Press  or Save soft key to save the configuration





To configure the record via Web Interface

1. Click Function keys → Memory key.
2. Select the desired Line or Memory key and select URL Record in the Type.
3. Click the  button to save the configuration.

Paging

With this feature, you can call a paging group directly.

To configure the paging via phone interface

1. Press Menu → Features → Function Keys → Memory keys as Function Keys → Memory key1 (for example)
2. Select the wanted Line or Memory key.
3. Press  and  or press  key to select the Paging.
4. Enter the paging code followed the number.
5. Press  or Save soft key to save the configuration



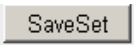



To configure the Paging via Web interface

1. Click Function keys → Memory key.
2. Select the desired Memory key and select Paging in the Type.
3. Enter the paging code followed the number.
4. Click the  button to save the configuration.

Shared Line

This feature allows subscribers to share SIP lines. Moreover it also provides status monitoring of the shared line.

To configure the line key as shared line via phone interface

1. Press Menu → Features → Function Keys → Line or Memory keys as Function Keys → Memory key1 (for example)
2. Select the wanted Line or Memory key.
3. Press  and  or press  key to select the Shared Line in the type field.
4. Press  and  or press  key to select the Account ID.
5. Enter the Label
6. Enter the Value
7. Press  or Save soft key to save the configuration

To configure the line key as shared line via Web Interface

1. Click Function keys → Line or Memory key.
2. Select the desired Line or Memory key and select Shared Line in the Type.
3. Enter the Value.

4. Enter the Label.
5. Select the Account ID
6. Click the  button to save the configuration and then restart.





Note:

This feature is not available on all servers. For more information, contact your system administrator.

Public Hold

The key can be configured as a public hold key. During a conversation, all members belonging to that particular SLA group can use this key to hold or resume a call.

To configure the Public hold via phone interface

1. Press Menu → Features → Function Keys → Line or Memory keys as Function Keys → Memory key1 (for example)
2. Select the wanted Line or Memory key.
3. Press  and  or press  key to select the Public Hold.
4. Press  or Save soft key to save the configuration

To configure public hold via Web Interface

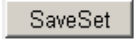
1. Click Function keys → Memory Key.
2. Select the desired Key and select public hold in the Type.
3. Click the  button to save the configuration.

Memory Key	Type	Value	Account	Pickup Code
Key1	Public Hold		Account 1	
Key2	N/A		Account 1	
Key3	N/A		Account 1	
Key4	N/A		Account 1	
Key5	N/A		Account 1	
Key6	N/A		Account 1	
Key7	N/A		Account 1	
Key8	N/A		Account 1	
Key9	N/A		Account 1	
Key10	N/A		Account 1	

NOTE





Key Type:
The free function key Type Speed Dial, BLF, Key Event, Intercom, URL.

BLF:
BLF setting require a phone restart

Private Hold

The key can be configured as a private hold key. During a conversation, all members belonging to that particular SLA group can use this key to hold the call, but only the initiator can resume the call.

To configure the Private hold via phone interface

1. Press Menu → Features → Function Keys → Line or Memory keys as Function Keys → Memory key1 (for example)
2. Select the wanted Line or Memory key.
3. Press  and  or press  key to select the Private Hold.
4. Press  or Save soft key to save the configuration

To configure private hold via Web Interface

1. Click Function keys → Memory Key.
2. Select the desired Key and select Private hold in the Type.
3. Click the  button to save the configuration.

Memory Key	Type	Value	Account	Pickup Code
Key1	Private Hold		Account 1	
Key2	N/A		Account 1	
Key3	N/A		Account 1	
Key4	N/A		Account 1	
Key5	N/A		Account 1	
Key6	N/A		Account 1	
Key7	N/A		Account 1	
Key8	N/A		Account 1	
Key9	N/A		Account 1	
Key10	N/A		Account 1	

NOTE

Key Type:
The free function key Type-Speed Dial,BLF,Key Event,intercom,URL.

BLF:
BLF setting require a phone restart

Share line

Shared line is configured by assigning the same extension number to multiple lines. You can use the shared line feature to share an extension number which is used on two or more IP phones at the same time. An incoming call to that number will cause all phones to ring simultaneously. The incoming call can be answered on one of the phones but not all of them. This feature is very useful in the boss and secretary scenario. For example, the secretary can share the boss' extension number on her phone. When there is an incoming call to the extension number of the boss, both the phones of the boss and the secretary will ring simultaneously. Either the boss or the secretary can answer the call. Calls on shared line can be placed on hold or barged in.

To configure the share line via phone interface

1. Press Menu → Features → Function Keys → Line or Memory keys as Function Keys → Memory key1 (for example)
2. Select the wanted Line or Memory key.
3. Press and or press key to select the share line.
4. Enter the number in the value field.
5. Select the desired account in the Account field.
6. Press or Save soft key to save the configuration

To configure the share line feature via web interface:

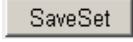
1. Click Function keys → Memory Key.
2. Select the desired Key and select share line in the Type.
3. Enter the number in the value field.
4. Select the desired account from the pull-down list of Account field.
5. Click the  button to save the configuration.

Note:

This feature is not available on all servers. For more information, contact your system administrator.





Hot Desking

Hot Desking originates from the definition of being the temporary physical occupant of a work station or surface by a particular employee. A primary motivation for Hot Desking is cost reduction. This feature is regularly used in places where not all the employees are in the office at the same time, or not in the office for very long at all, which means actual personal offices would be often vacant, consuming valuable space and resources.

You can use Hot Desking on the IP phone to logout the existing accounts and then log in a new account, that is, many users can share the phone resource in different time. To use this feature, you need to configure a Hot Desking key in advance.

This feature is supported on the version 1.0.3.82 or later

To configure the hot desking via phone interface

1. Press Menu → Features → Function Keys → Line or Memory keys as Function Keys → Memory key1(for example)
2. Select the wanted Line or Memory key.
3. Press  and  or press  key to select the hot desking.
4. Enter the display name in the value field.
5. Press  or Save soft key to save the configuration

To configure the hot desking via web interface:

1. Click Function keys →Memory Key.
2. Select the desired Key and select hot desking in the Type.
3. Enter the number in the value field.
4. Select the desired account from the pull-down list of Account field.
5. Click the  button to save the configuration.

To use the Hot desking feature on the user interface:

1. Press the Hot desking key when the IP Phone is idle.
2. Enter the Extension number and password

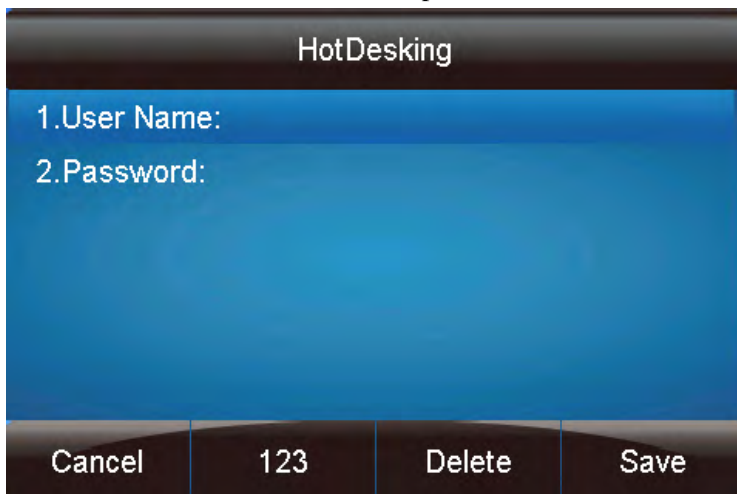

3. Click Save softkey

You can see the account information which has changed.

Note:





This feature is not available on all servers. For more information, contact your system administrator.

ACD (Pending)

ACD feature is often used in offices for customer service, such as call center. The ACD system handles large volumes of incoming calls from callers who have no need to talk to a specific person but who require assistance from any of multiple persons at the earliest opportunity. The ACD feature on the Htek IP Phone allows the ACD system to distribute calls from large volumes of

incoming calls to the registered IP phone users. To use this feature, you should configure an ACD key in advance.

To configure the ACD via phone interface

1. Press Menu → Features → Function Keys → Line or Memory keys as Function Keys → Memory key1 (for example)
2. Select the wanted Line or Memory key.
3. Press  and  or press  key to select the ACD.
4. Enter the label in the label field.
5. Select the desired account in the Account field.
6. Press  or Save soft key to save the configuration

To configure the ACD via web interface:

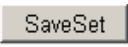
1. Click Function keys → Memory Key.
2. Select the desired Key and select ACD in the Type.
3. Enter the label in the label field.
4. Select the desired account from the pull-down list of Account field.
5. Click the  button to save the configuration.





Note:

This feature is not available on all servers. For more information, contact your system administrator.

Zero Touch

You can use this key feature to configure auto provision and network parameters quickly. This feature is supported on the version 1.0.3.82 or later

To configure the zero touch via phone interface

1. Press Menu → Features → Function Keys → Line or Memory keys as Function Keys → Memory key1 (for example)
2. Select the wanted Line or Memory key.
3. Press  and  or press  key to select the zero touch
4. Press  or Save soft key to save the configuration

To configure the zero touch via web interface:

1. Click Function keys → Memory Key.
2. Select the desired Key and select zero touch in the Type.
3. Click the  button to save the configuration.

To use the zero touch feature on the user interface:

1. Press the zero touch key when the IP Phone is idle.
2. The IP Phone will enter the WAN Port interface, you can change the WAN Type by pressing the Navigation keys.
3. Press the Next softkey to enter Network interface, then you can configure some information.
4. Press the Next softkey again, you can configure auto provision information.
5. When you finish the setting, you can press the OK to accept the changes.

Note:

This feature is not available on all servers. For more information, contact your system administrator.

Upgrade

Factory Reset

To set Factory Reset by phone interface

1. Press Menu → Setting → Advanced Setting(default password: admin)→ Factory Reset
2. Press OK soft key in the warning page.

To set Factory Reset via web interface

1. Click Management → Upgrade
2. Click and then confirm the setting.



Pcap Feature

To use pcap via web interface:

1. Click Management→Tools
2. Click Start and then operation the phone
3. When finish the operation, click stop and then click Export.
4. Then you'll get the Pcap captures.

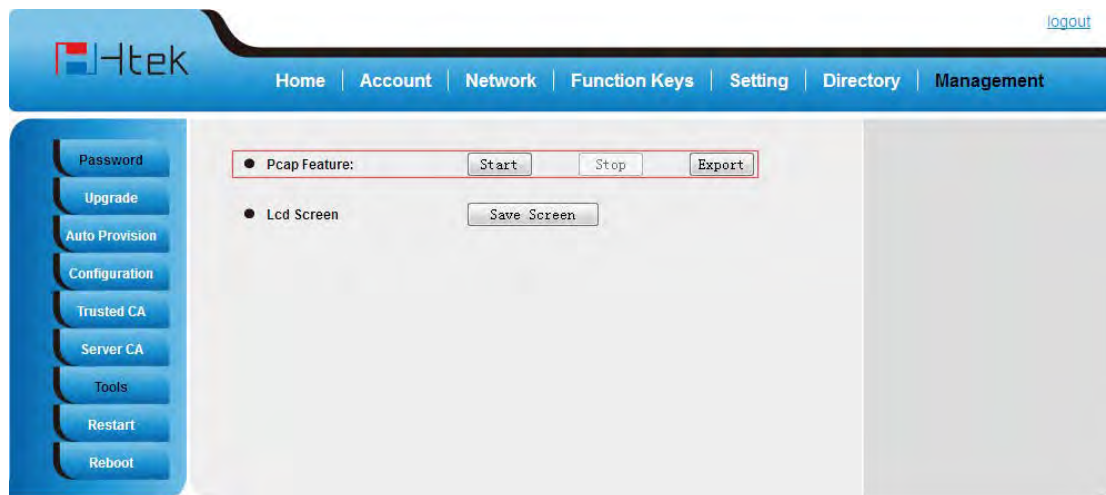

System Log

To download system log via web interface:

1. Click Management → Configuration
2. Click  of the system Log
3. Then you'll get a txt file: syslog.txt.

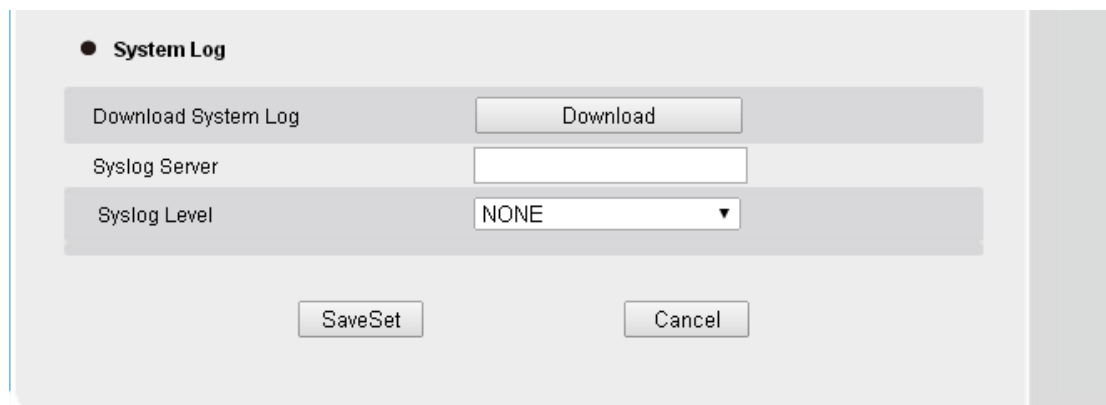
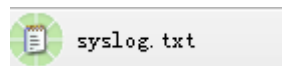

Upgrade

To upgrade via HTTP, the “Management” → “auto provision” → “Firmware Upgrade” → “Upgrade Mode” field needs to be set to HTTP, respectively. “Firmware Server Path” needs to be set to a

valid URL of a HTTP server, server name can be in either FQDN or IP address format. Here are examples of some valid URL.

e.g. firmware.mycompany.com:5688/Hanlong

e.g. www.mycompany.com:5688/fm/ Hanlong

e.g. 218.2.83.110

Instructions for firmware upgrade via HTTP:

- (1) End users can choose to download the free HTTP server from <http://httpd.apache.org/> or use Microsoft IIS web server. Then setup HTTP server.
- (2) Unzip the firmware file and put all of them under the *root/fm* directory of the HTTP server.
- (3) Visiting “HTTP:\\192.168.0.254\fm\fw8xx.rom on localhost by browser” to verify the HTTP Server. If visiting “HTTP: \\192.168.0.254\fm\fw8xx.rom on other computer is no prompt to download fw8xx.rom file, please check the firewall (Suggest close the firewall).

To configure the server path via web interface:

1. Click Management → Auto provision:
2. Select the upgrade mode in the upgrade mode field
3. Enter the Firmware server path and config server path (192.168.0.254 is HTTP server).
4. Enter the HTTP server’s username and password (optional).
5. Click the  button to save the configuration.
6. Restart the UC8xx, IP Phone will restart and auto-get firmware files from HTTP server.

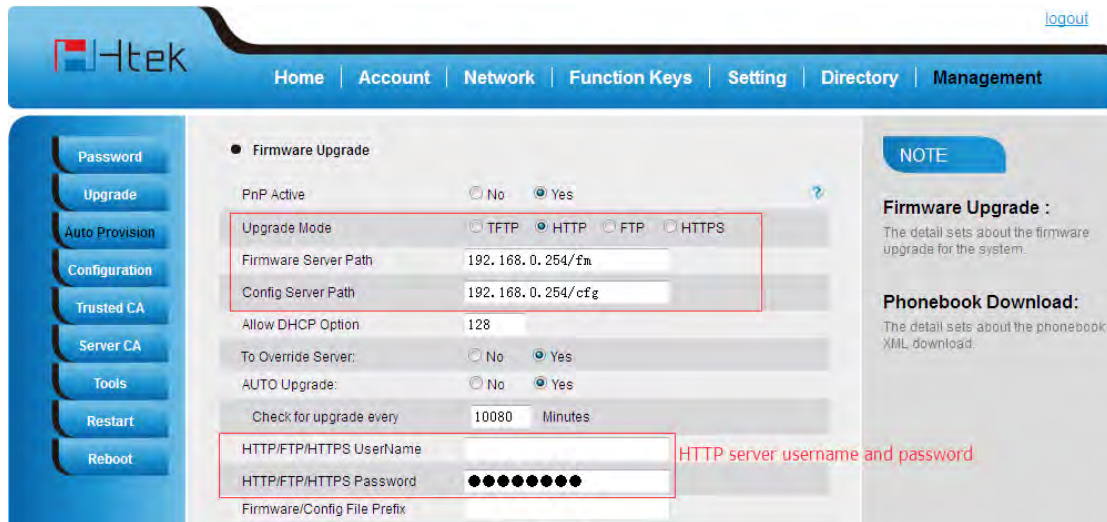

NOTES:

- Hanlong recommends end-user use the Hanlong HTTP server. For large companies, we recommend to maintain their own TFTP/HTTP/FTP/HTTPS server for upgrade and provisioning procedures.
- Once a “Firmware Server Path” is set, user needs to update the settings and restart the IP Phone. If the configured firmware server is found and a new code image is available, the

UC8xx will attempt to retrieve the new image files by downloading them into the UC8xx's SDRAM. During this stage, the UC8xx's LEDs will blink fastly until the checking/downloading process is completed. Upon verification of checksum, the new code image will then be saved into the Flash. If TFTP/HTTP/FTP/HTTPS fails for any reason (e.g. TFTP/HTTP/FTP/HTTPS server is not responding, there are no code image files available for upgrade, or checksum test fails, etc), the UC8xx will stop the TFTP/HTTP/FTP/HTTPS process and simply boot using the existing code image in the flash.

- Firmware upgrade may take as long as 3 to 8 minutes over Internet, or just 1 minutes if it is performed on a LAN. It is recommended to conduct firmware upgrade in a controlled LAN environment if possible. For users who do not have a local firmware upgrade server.
- Hanlong's latest firmware is available at <http://www.h-tek.com> →Support→Firmware Download.
- Oversea users are strongly recommended to download the binary files and upgrade firmware locally in a controlled LAN environment.

To upgrade manually via the Web configuration interface

1. Click Management → Upgrade
2. Click Brower or the blank.
3. Select the firmware (fw8xx.rom)and then click .

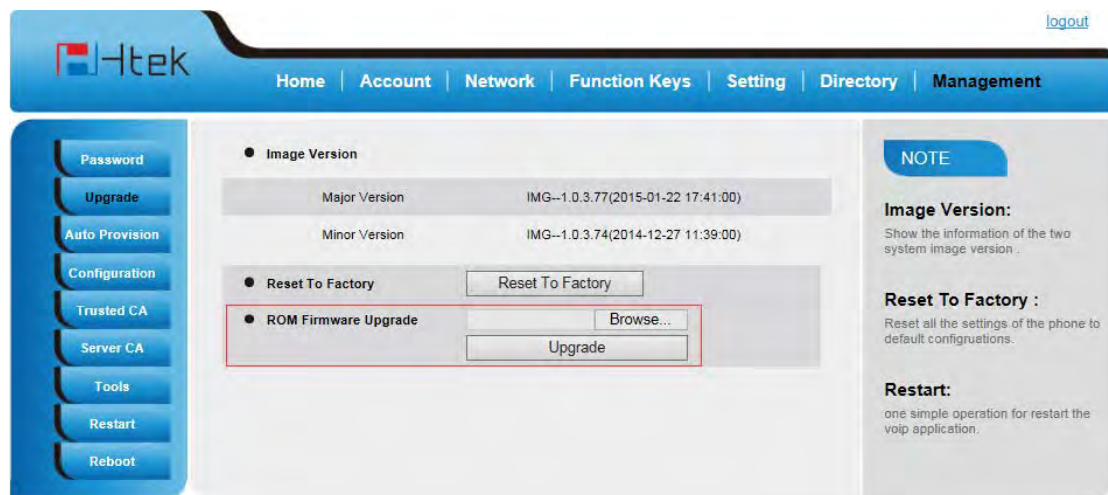

Configuration File

To download configuration file:

1. Click Management → Configuration →Download Device Configuration

2. Then you can get a file: cfg.bin or cfg.xml

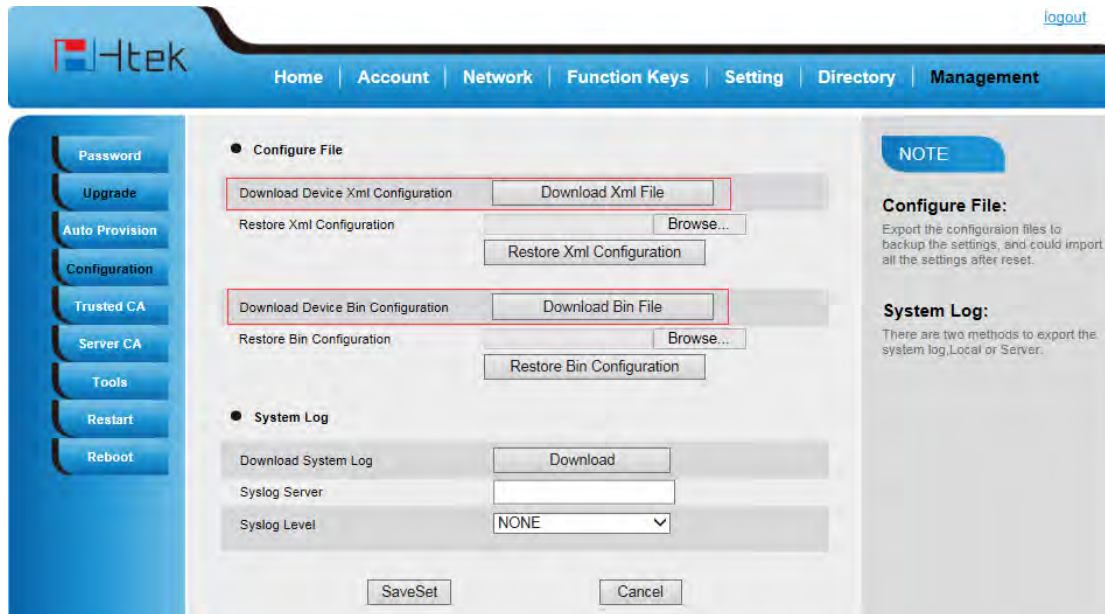

To Restore a configuration file:

1. Click Management → Configuration → Restore configuration

2. Select the xxx.bin or xxx.xml file, and then Click the **Restore Bin Configuration** , then IP Phone will reboot.

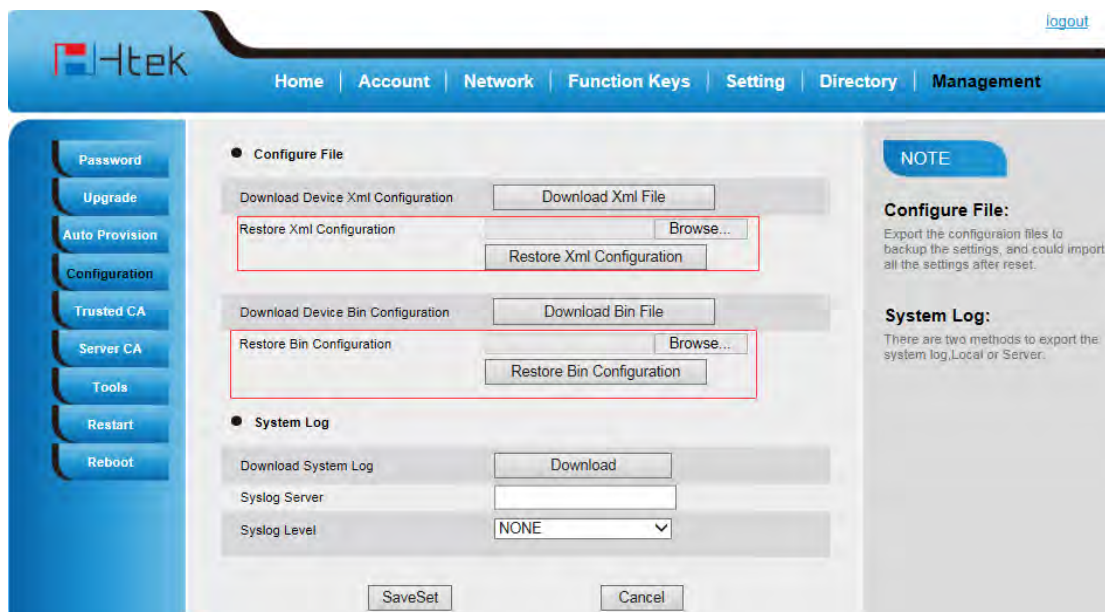

Troubleshooting

Why is the phone LCD screen blank?

1. Ensure your phone is properly plugged into a functional AC outlet.
2. Ensure that the phone isn't plugged into a plug controlled by a switch that is off.
3. If the phone is plugged into a power strip, try plugging it directly into a wall outlet instead.
4. If your phone is powered from PoE, ensure you use a PoE compliant switch or hub, or contact your system administrator for more information.
5. Check that the power LED is on to ensure the phone is powered on.

Why does the phone display "Network Unavailable"?

- Ensure that the Ethernet cable is plugged into the Internet port on the phone and the Ethernet cable is not loose.
- Ensure that the switch or hub in your network is operational.
- Contact your system administrator for more information.

Why can't I get a dial tone?

- Check for any loose connections and that the phone has been installed properly. For the Installation instructions, refer to [Phone Installation](#).
- Check whether dial tone is present on one of the audio modes.
- Switch between the Handset, Headset (if present) or Hands-Free Speakerphone to check whether dial tone is present for one of the audio modes.
- If the dial tone exists on another audio mode, connect a different handset or headset to isolate the problem.

Where to set the tone?

You can set the tone on web interface:

- Click Setting→Tones
- Define the dial tone, ringing, busy tone...
- For the tones, you can check with your system administrator.
- More Click [Tone Notes](#).

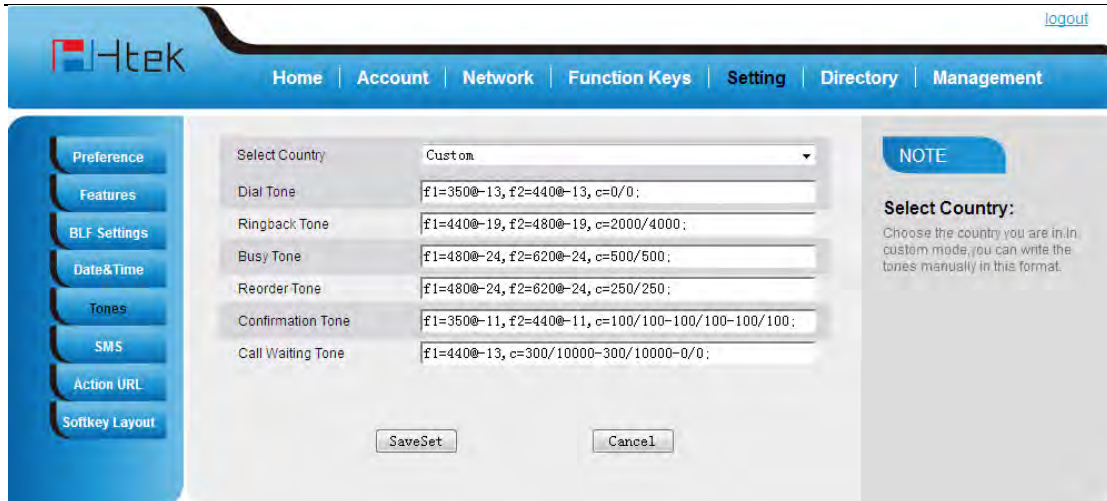

How to download XML Configuration?

- Click Management → Configuration → [Download Xml File](#)

How to Import Trusted CA certificate?

- Click Management → Trusted CA

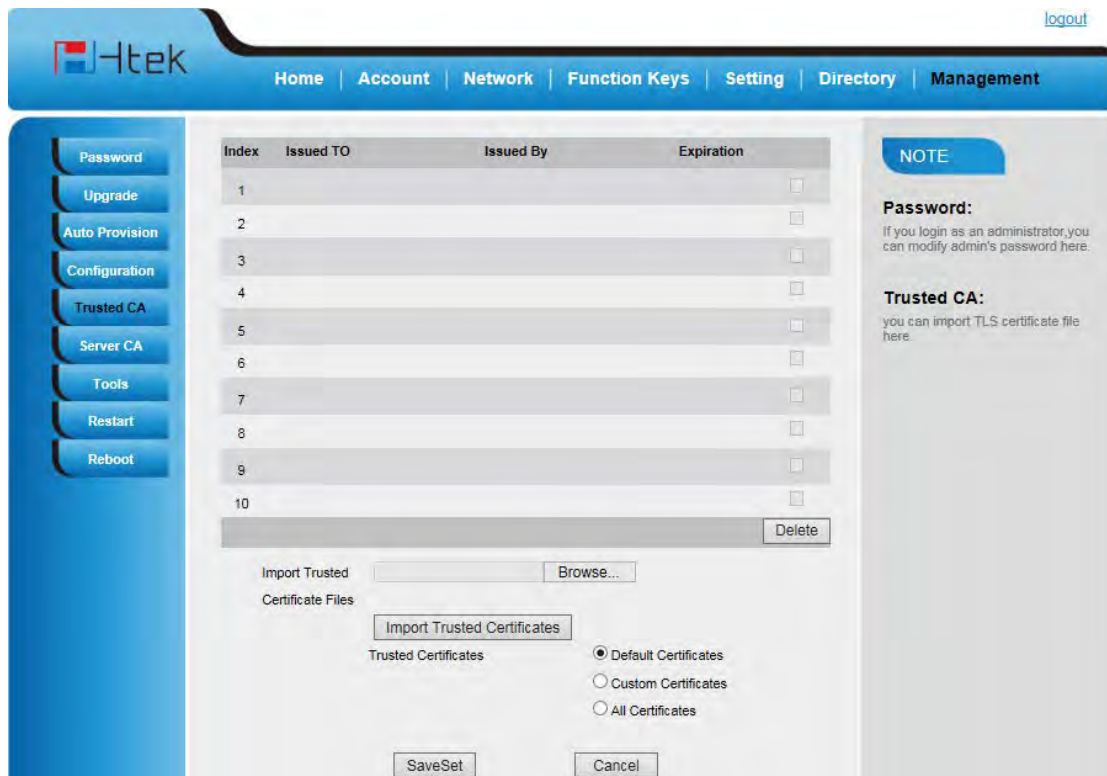

How to Import Server CA certificate?

- Click Management→Server CA

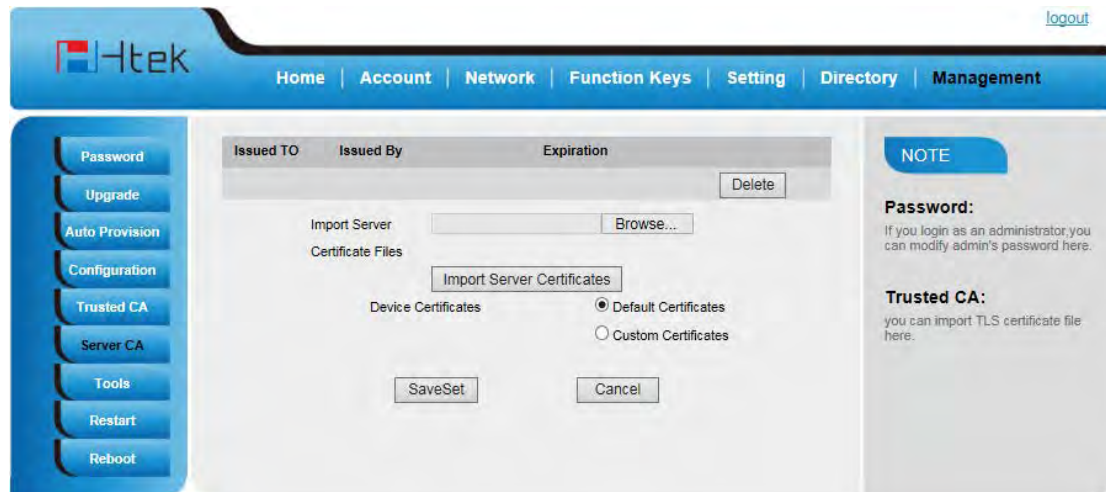

How to use Vlan?

- For Vlan information, please click [VLAN Note](#)

How to use LLDP?

- For LLDP information, please click [VLAN Note](#)
- VLAN Notes including:
 1. Voice VLAN
 2. Major Benefits of Using VLANs
 3. VLAN discovery method on Htek ip phones
 4. LLDP Feature on Htek IP Phones
 5. Supported TLVS of IP Phones
 6. Configuring LLDP Feature
 7. DHCP VLAN
 8. Open the DHCP VLAN on the Htek IP Phones
 9. VLAN under Bridge Mode
 10. VLAN under NAT Mode

How to Set LCD and Web GUI:

- Click [LCD and Web GUI custom Guide](#)

How to Upgrade via FTP?

- Click [How to Upgrade Note](#)

How to make Ringtone?

- Click [How to Make Ringtone](#)

How to use Open VPN?

- Click [Open VPN note](#)

Provisioning Guide on Free PBX:

- Click [Set Auto Provision on FreePBX](#)

Failover Notes

- Click [Failover Note](#)

How to Upload Wallpaper?

- Click [Wallpaper Upload Notes](#)

How to Use Auto Provision Phonebook?

- Click [About AP Phonebook](#)

All Documents

- Click [Documents Guide](#), you can get all tech files.